

# **Distributed Energy Roles for Geothermal Resources in New Zealand**

Prepared by

Brian White and Barrie Wilkinson

East Harbour Management Services



23 June 2008



**Photograph 1:** A hot stream at Waikite. There is potential for geothermal energy developments at many places throughout New Zealand.

## Table of Contents





<b>Summary</b> .....	<b>4</b>
<b>1 Background</b> .....	<b>6</b>
<b>2 The Enabling Technologies</b> .....	<b>8</b>
2.1 Distributed Energy .....	8
2.2 Geothermal Technologies for Distributed Energy Applications .....	8
2.2.1 Geothermal Heat Pumps .....	9
2.2.2 Conventional Geothermal Energy Sources.....	13
2.2.3 Geothermal Fluid Disposal .....	15
2.2.4 Geothermal Direct Use Applications .....	16
2.2.5 Small-sized Electricity Generation (2 to 30 MW).....	20
2.2.6 Mini-sized Electricity Generation (200 kW to 2 MW).....	23
2.3 Exceptional Large Scale Developments.....	25
<b>3 Geothermal Resource Requirements and Areas of Technology Applicability</b> .....	<b>27</b>
3.1 Lindal Chart Relating Temperature and Application .....	27
3.2 Geothermal Heat Pumps.....	27
3.3 Water for Bathing, Aquaculture or Low Temperature Heating .....	29
3.3.1 Potential Engineered Systems .....	29
3.3.2 Conventional Geothermal Systems .....	31
3.4 Areas for Higher Temperature Applications (Including Electricity Generation).....	32
<b>4 Attractiveness of the Investment</b> .....	<b>33</b>
4.1 Nature of Geothermal Investment .....	33
4.2 Geothermal Heat Pumps.....	33
4.3 Low Temperature Heating.....	35
4.3.1 Potential Engineered Systems .....	35
4.3.2 Conventional Geothermal Developments .....	36
4.4 Industrial Heat Supply from High Temperature Fields .....	37
4.5 Small-sized Electricity Generation (2 to 30 MW) .....	39
4.6 Mini-sized Electricity Generation (200 kW to 2 MW).....	40
<b>5 Potential For, and Methods To, Increase Uptake of Distributed Energy Opportunities</b> .....	<b>41</b>
<b>6 References</b> .....	<b>45</b>
<b>Appendix 1: Description of a Lithium Bromide Absorption Cycle</b> .....	<b>46</b>

## Summary

In many situations geothermal energy has the potential to meet demand for distributed energy at commercially competitive prices. It is a renewable resource, producing zero or low carbon emissions, is favoured by Government policies and relative economics will improve with the application of a carbon cost across the economy. With appropriate design it can have minimal adverse environmental impact.

Development options associated with high temperature resources are distributed in restricted areas geographically, but there are other options based on lower temperature resources which have potential essentially anywhere in New Zealand.

**Table ES 1:** Comparison of potential geothermal applications and associated resource location

	Heat Pump Applications	Enhanced Systems for Heat (or Electricity)	Conventional Heat Applications	Electricity Generation
<b>Location</b>				
<b>Comments</b>	<ul style="list-style-type: none"> <li>• Potential national application</li> <li>• Best areas have not been defined</li> </ul>	<ul style="list-style-type: none"> <li>• Potential national application</li> <li>• Best areas have not been defined</li> <li>• Basic research is required</li> </ul>	<ul style="list-style-type: none"> <li>• Localised application</li> <li>• Data is being collected</li> <li>• Resource size is being assessed under low temperature research funded by FRST</li> </ul>	<ul style="list-style-type: none"> <li>• Narrowly defined resources</li> <li>• Some resources are effectively protected from large scale development</li> </ul>

In addition, geothermal heat pump applications, producing heat from low temperature ground and water sources are largely unrestricted in location (though are more attractive when associated with water-sources) and are likely to be economically attractive for large domestic and commercial-scale heating loads, especially in cooler areas subject to frosts and snow, where air-sourced heat pumps can be much less effective. Geothermal heat pumps are unlikely to be economic for small domestic loads unless aggregated with other domestic loads and with water heating to give an economy of scale and higher load factor. One potential application is for schools. These larger scale developments are needed for geothermal heat pumps to be able to compete with air source heat pumps and other heating options.

Costs are given in the report for possible low temperature (<60°C) developments outside conventional geothermal areas, based on the natural thermal gradient evident over much of the country. By way of example, such developments can include hot pool/spa applications, and simple analysis indicates these applications may be financially attractive. There are a range of potential applications in this temperature range.

Costs for conventional geothermal heating options have also been assessed for application on any of the many listed geothermal fields and warm or hot spring systems in New Zealand. There are extensive resources both in the South and North Islands, though the focus for development is generally in the upper half of the North Island. These geothermal options are seen as competitive with a range of other heat supply options, for large domestic loads to those of commercial scale. Clearly, applications will be less economic where the resource temperature is low or where there are only small economies of scale.

Industrial (or large commercial) heat supplies will generally be restricted to locations above high temperature geothermal fields in the Taupo Volcanic Zone and Ngawha. A variation on industrial heating from geothermal energy is the option of deep drilling outside conventional geothermal fields to intersect the heat from natural gradients, although this has not been costed for this report. For conventional high temperature developments, a green field development requires a load greater than (say) 10 – 20 MW<sub>th</sub> to be widely competitive with other energy options. This threshold development size will be greater for deep drilling options. Where energy consumers are co-located with a large geothermal electricity generating power station (or large industrial heat supply), then it should be possible to supply steam (or hot water depending on the heating duty required) from the facility at competitive prices (assuming the capital cost of the alternative heat plant is taken into account).

Electricity generation from geothermal sources is possible on high temperature fields in the Taupo Volcanic Zone and Ngawha. At larger scale and with favourable resource characteristics (high temperatures and productive wells) this is one of the most attractive generation investments in terms of unit cost. However, there are also some targeted small scale distributed energy developments that could be viable, based on exploitation of boiling springs or existing wells. Several manufacturers are now developing equipment at the 250kW<sub>e</sub> scale that could be readily adapted to this type of application.

# 1 Background

Because of attention paid over the last half century to the use of geothermal energy for electricity generation, there has arisen an incorrect impression that geothermal energy utilisation is applicable only to large central power stations, and that it has little role to play in satisfying New Zealand's energy needs via locally distributed energy supply or smaller scale electricity generation. The report addresses this, demonstrating the considerable potential of distributed geothermal energy, both from conventional geothermal resources and also from non-conventional resources, say via heat pumps or through exploiting the natural thermal gradient evident in any part of the country.

Direct use in New Zealand has continued to grow, with a recent focus on commercial and industrial applications. Figure 1.1 shows trends in geothermal direct heat use, and geothermal electricity generation, illustrating that growth in direct heat use has been significant throughout the period of commercial geothermal development in New Zealand's history.

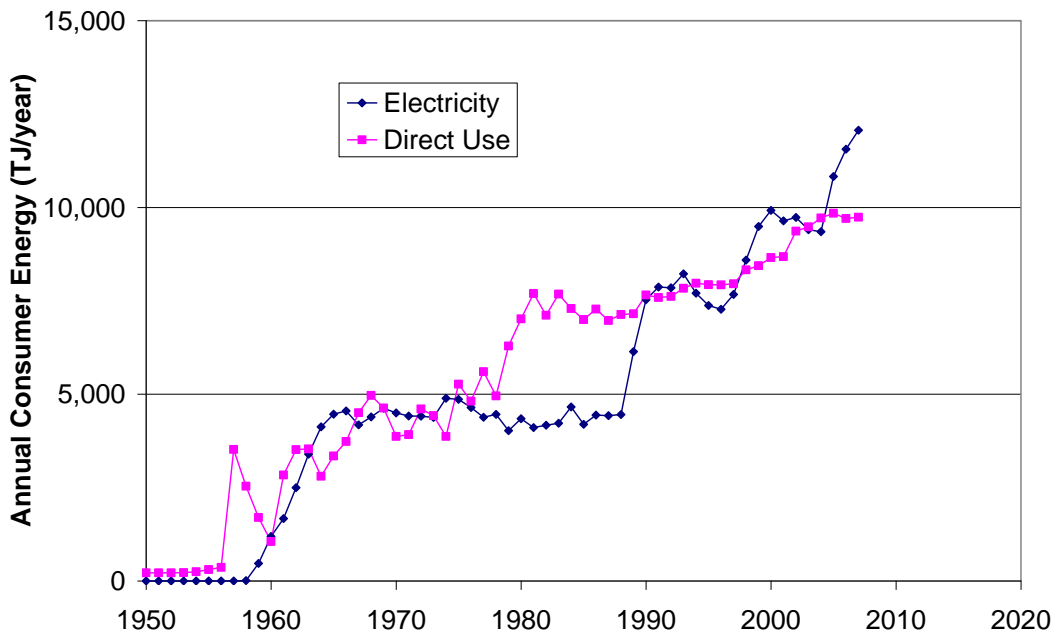

**Figure 1.1.** Recent trends in geothermal direct heat use in New Zealand compared with geothermal electricity generation (White 2007)

The upward growth in both geothermal heat and electricity demand seen in Figure 1.1 is underpinned by rising demand for heat and electricity nationally. Heat requirements are a function of industry and domestic needs. Nationally, New Zealand faces calls to add value to products e.g. through kiln drying of timber for better control of quality. Domestically, there is now a recognition that our homes have generally been too cold and this is affecting the availability and productivity of our workforce. This latter factor should lead to changes in home design and may lead to increasing demand for heat whether from electricity or other sources, including geothermal sources. Nationally, in terms of our electricity demand, there is an expectation that our demand will rise by about 2% per year (660GWh/year) (White 2007). This is equivalent to a new 80MW base-load power station each year, but will be satisfied by a range of generation options, both from large centralised stations and from smaller distributed generation options, including geothermal electricity generation opportunities.

The New Zealand Geothermal Association's role is to ensure that geothermal energy meets its full potential: whether generating electricity, supplying heat to meet major industrial loads, or addressing smaller loads, including such applications as heat pumps.

In October 2007 the New Zealand Government published a New Zealand Energy Strategy (NZES), which, amongst other things, places a strong emphasis on encouraging the uptake of renewable energy sources, of which geothermal energy is one example. The New Zealand Energy Efficiency and Conservation Strategy (NZEECS), published in parallel with the NZES sets out an action plan for implementing the NZES. The NZEECS and NZES have the specific target "to have 90 per cent of electricity generated from renewable sources by 2025". The Government has also proposed a moratorium on some fossil-fuelled thermal generation. Parallel policy work proposed the introduction of a carbon emissions trading scheme.

The New Zealand Government, particularly through the Ministry of Economic Development and through the Energy Efficiency and Conservation Authority, has a strong interest in encouraging distributed energy,. For many years, Government policy statements on electricity have included the objective of "ensuring that electricity is delivered in an efficient, fair, reliable and environmentally sustainable manner to all classes of consumer".

These policies and the pending (subject to legislation) introduction of an emissions trading scheme (in 2010 for stationary energy including electricity) serve to create an environment in which the prospects for investment in geothermal energy are considerably enhanced, and in many cases may be economic.

Recent public discussion documents on distributed electricity generation have highlighted the following benefits of distributed energy:

- Helps to meet demand growth – with distributed energy options broadening the range of potential sources of energy.
- Facilitates market entry and competition – the smaller scale of distributed projects removing some barriers to new entry, and potentially to financing.
- Reduces line losses and may defer network investment – for distributed energy: this argument applying to both electricity and gas lines.
- Enhances security of energy supply – in particular with respect to the networks which must otherwise supply the load.
- Provides climate change benefits – particularly where energy sources are associated with low carbon emissions, and reduce line losses.

This project was identified by the New Zealand Geothermal Association as part of its 2007/8 Action Plan, and has been funded by the Energy Efficiency and Conservation Authority.

## 2 The Enabling Technologies

### 2.1 Distributed Energy

The term “distributed energy” refers to the decentralised generation of electricity (both for grid-connected and off-grid generators) and use of energy, normally for heating, cooling or powering a process on a site or in a locality.

### 2.2 Geothermal Technologies for Distributed Energy Applications

The main technologies normally associated with distributed geothermal energy include:

- Geothermal heat pumps
- Direct use from:
  - Wells
  - Other energy sources such as springs or hot streams
- Direct use for:
  - Heating
  - Cooling
- Small-sized electricity generation (say of the order of 2 – 30MW)
- Mini-sized electricity generation (say 200kW to 2 MW)

These technologies are described in the following sections.

Within the category of direct use, the following international trends in application of geothermal energy have been reported by Lund *et al* at the World Geothermal Congress 2005<sup>1</sup>, and are summarised in Table 2.1 and Figure 2.1.

**Table 2.1:** Summary of the Various Worldwide Direct Use Categories (Utilisation TJ/year) (Lund *et al* 2005)

	1995	2000	2005
Geothermal heat pumps	14,617	23,275	86,673
Space heating	38,230	42,926	52,868
Greenhouse heating	15,742	17,864	19,607
Aquaculture pond heating	13,493	11,733	10,969
Agricultural drying	1,124	1,038	2,013
Industrial uses	10,120	10,220	11,068
Bathing and swimming	15,742	79,546	75,289
Cooling/snow melting	1,124	1,063	1,885
Others	2,249	3,034	1,045
<b>Total</b>	<b>112,441</b>	<b>190,699</b>	<b>261,418</b>

<sup>1</sup> Lund, JW, Freeston, DH and TL Boyd (2005) *World-Wide Direct Uses of Geothermal Energy 2005*. Proceedings World Geothermal Congress 2005 Antalya, Turkey



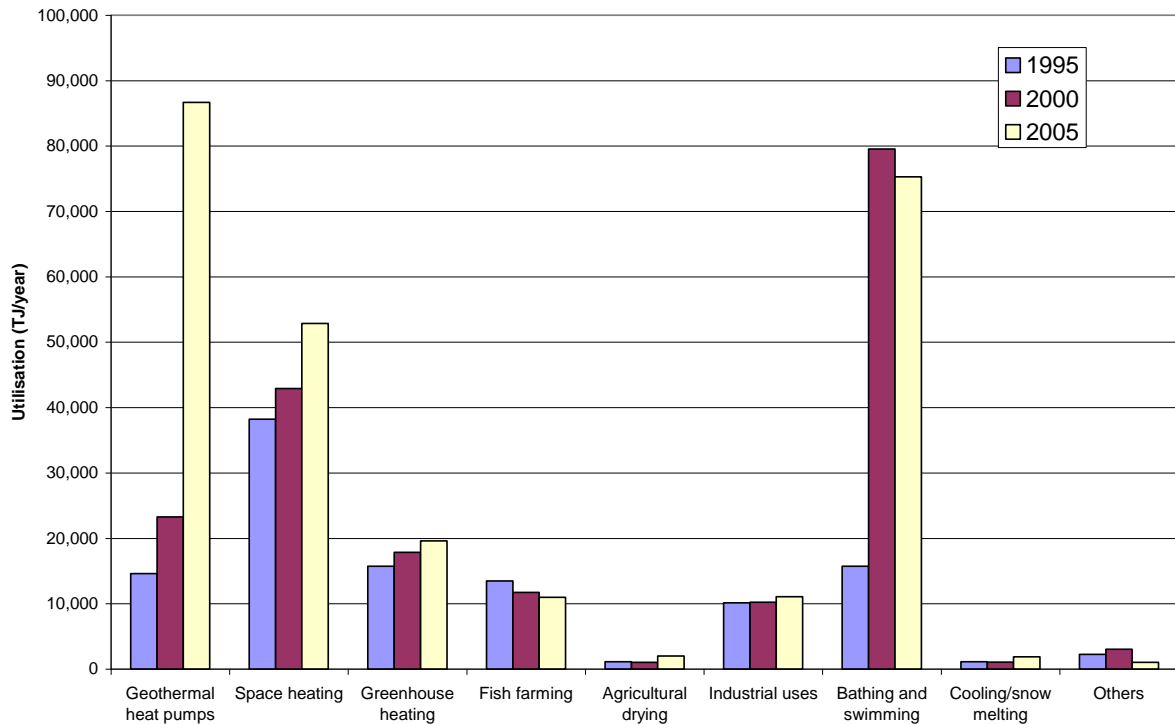

**Figure 2.1:** Graphical presentation of worldwide use emphasising dominant categories and areas of growth

Several conclusions can be taken from Table 2.1 and Figure 2.1. Most notably, geothermal heat pump applications have been subject to enormous growth rates and now dominate as the single largest category of geothermal direct use in the world<sup>2</sup>. Direct space heating applications have also enjoyed very rapid growth and given that the predominant application for heat pumps is in space heating, around 70% of world use is in this category. New Zealand is unusual in having very considerable industrial direct use of geothermal energy with Kawerau wood processors accounting for just over half of the world's industrial use of geothermal energy. Clearly demands of this magnitude, coinciding with a geothermal resource are exceptional.

In addition to direct heat use, development of geothermal energy for electricity generation is increasing both at large and small scale.

## 2.2.1 Geothermal Heat Pumps

### 2.2.1.1 Operating Principles

Heat pumps work in a similar way to refrigerators – they take heat from one place and transfer it to another using electrically-driven compressors (Figure 2.2). The main difference between a heat pump and a refrigerator unit is that refrigeration units only cool while heat pumps normally heat, though they may also be reversed for cooling.

<sup>2</sup> A recent news article reported that in China geothermal heat pump energy delivered rose from 6,570 TJ/year in 2004 to 17,140 TJ/year in 2006, emphasising the rapid growth of this market segment.

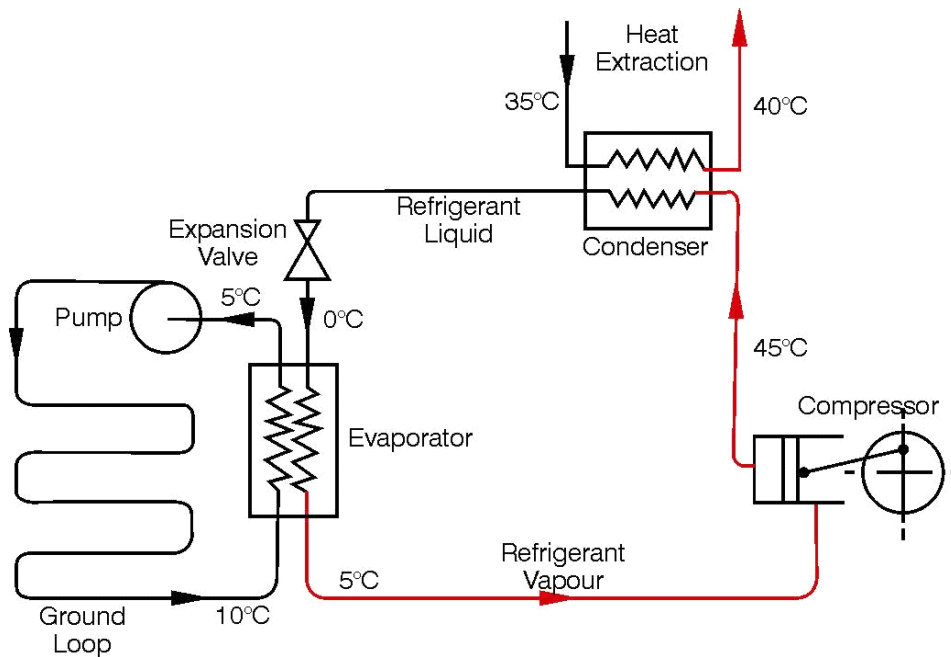

**Figure 2.2.** Typical components of a heat pump system (Thain et al 2006)

The electrical energy to run the system is a fraction of the final heat delivered. Depending on the type of heat pump system used it is possible to get 3 – 6 kW of heating from 1 kW of electricity, with the ratio being known as the Coefficient of Performance (COP). Normal electric resistance heaters have a COP of one. Heat pumps are more expensive to buy and install than resistance heaters, but may be justified on the basis of avoided alternative electricity or heat costs over the life of the heat pump.

Most installed heat pumps are air-sourced, utilising heat drawn from the air outside the building for transfer indoors. Approximately 80,000 air-sourced heat pumps were installed in New Zealand in 2007 while geothermal heat pumps would have been numbered in their tens. Although air-sourced systems can have high efficiency under ideal conditions (COPs up to 5 for large commercial units), their efficiency decreases as the outside air temperature cools with the seasons or between day and night. Essentially more electrical work must be done in colder conditions because there is less heat in the air and a greater temperature difference between the outside temperature and the desired inside temperature. Average COPs end up in the 2-3.5 range.

Geothermal heat pump systems (also known as ground source heat pumps) are very similar to air-source heat pumps, but take advantage of the thermal inertia in the ground or in surface waters anywhere in New Zealand. Temperatures do not vary in ground or water as much as in air, as illustrated in Figure 2.3, largely because of their greater thermal mass. There is no reliance, for heat pump use, on elevated ground temperatures (though higher temperatures improve efficiency) as found in traditional “geothermal” environments, so geothermal heat pumps can be installed anywhere where the ground is adequately conductive; this essentially requiring moist conditions.

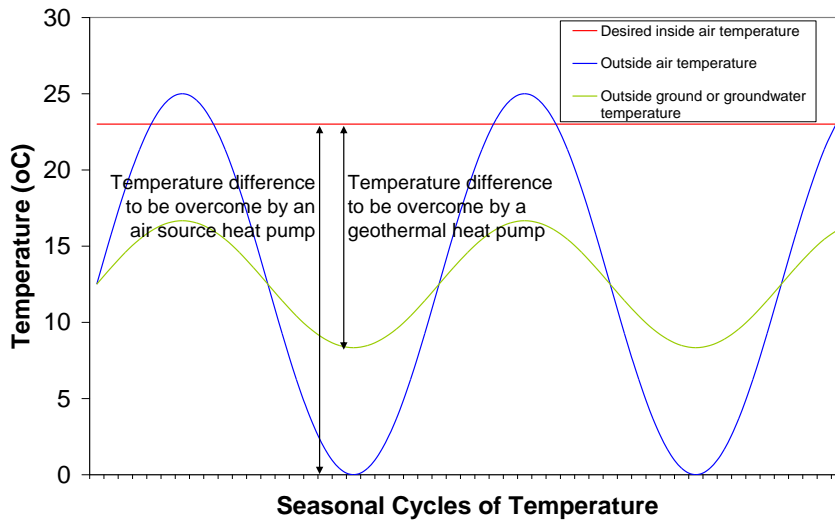

Figure 2.3. Illustration of the steadier ground temperatures for a geothermal heat pump that contribute to its higher overall efficiency than air source heat pumps (EECA 2007).

### 2.2.1.2 Geothermal Heat Pump Types

There are a range of designs which are summarised in Figure 2.4.

#### GEOTHERMAL HEAT PUMPS (GHP) a.k.a. Ground Source Heat Pumps (GSHP)

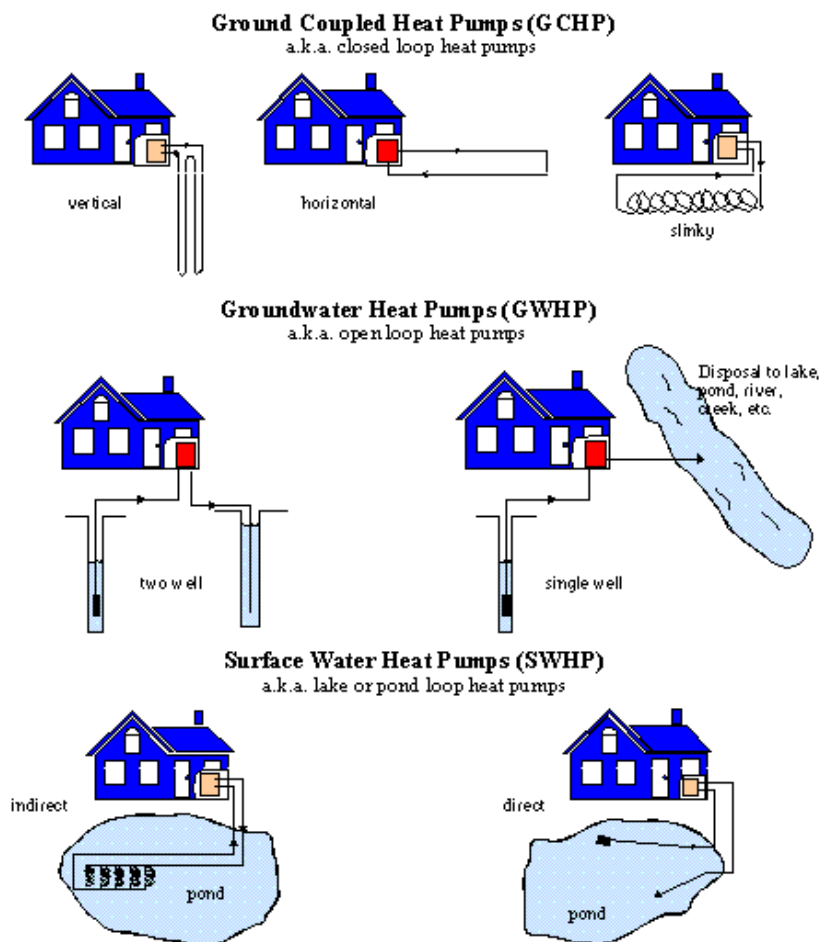

Figure 2.4. Typical designs for geothermal heat pump installations

The systems use the following means of extracting heat:

- External closed loop ground source system with polyethylene pipe acting as a heat exchanger with the ground, either:
  - Placed horizontally in a trench, say a slightly deeper services trench of around 1-2 m depth – can be undertaken by building contractors (about 50% of US applications), or
  - Run in vertical boreholes (possibly not much deeper than pile foundation holes) – the work would be undertaken by groundwater drillers (about 35% of US applications).
- Pumping surface water (in about 15% of US applications, but a dominant proportion of current New Zealand applications), either:
  - Directly through a heat pump, or
  - To an area in which polyethylene pipe has been laid for a closed loop system.

The pipe within the trench or well is normally thin-walled polyethylene pipe that acts as a heat exchanger, and contains water and possibly antifreeze.

The heat pump provides space heating or cooling by:

- Heating or cooling air which is then ducted to various areas of the building
- Delivering warm water either:
  - To radiators located on walls, or
  - To an underfloor heating system, made up of a labyrinth of polyethylene pipes embedded in the concrete floor of a house<sup>3</sup>.

Where warm water is required, heat pumps can also be used to heat water for household hot water requirements or for swimming pools.

The design applications for distributing heat are similar for any fuel source: geothermal, electricity, gas, coal or oil. It follows that retrofitting a geothermal heat pump system can readily be done. Normally such systems will have programmable control systems and zoned heating for convenience and efficiency.

There are obvious environmental and energy savings associated with use of these systems, though some electricity is used for pumping fluids. In addition, geothermal heat pumps take up little space, operation is relatively quiet and there is virtually no concern for coil freezing in contrast to air-source heat pumps.

Domestically there are examples of geothermal heat pump systems installed in large New Zealand houses and domestic applications overseas are relatively common in some areas. A recent New Zealand commercial installation was at Dunedin airport using pumped local groundwater as the heat source.

In the USA geothermal heat pump systems have been widely used since the mid-1980s. Internationally, application examples include heating the Sydney Opera House, apartment

---

<sup>3</sup> Underfloor systems are superior for delivering space heating, but the method cannot produce space cooling because the cold surface is likely to cause air moisture to condense on the floor.

and high rise buildings, and use in schools particularly in the USA. Schools offer large playing fields in which loops can be laid, and existing radiator systems that allow retrofitting.

Traditionally geothermal heat pump systems in New Zealand have working fluid temperatures around the 50°C range, which is adequate for space heating and preheating domestic hot water. New designs have working temperatures in the 70°C range, allowing full substitution of electric or gas hot water systems. The efficiency of the units might be expected to decrease for these more difficult duties.

Global trends in heat pump installation are shown in Figure 2.5

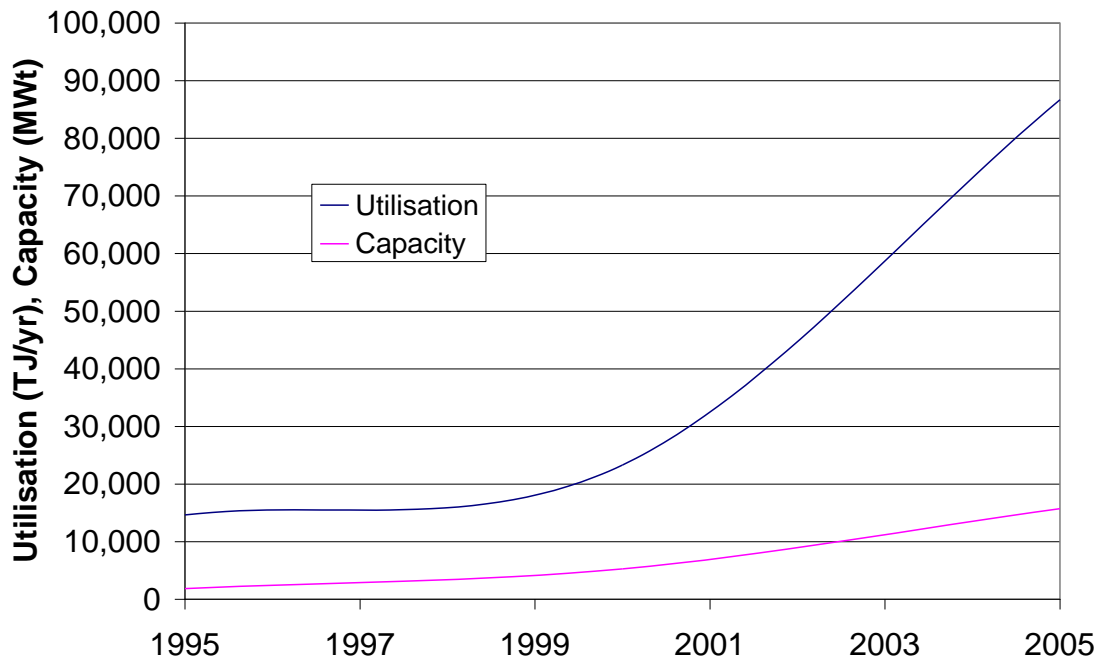

**Figure 2.5.** Illustration of the accelerated worldwide uptake of geothermal heat pumps over the last decade (data from Lund et al 2005).

## 2.2.2 Conventional Geothermal Energy Sources

A recent survey of users shows the following sources of geothermal heat (EECA 2007):

- Naturally warm ground – siting of dwellings on warm soil was one of the traditional methods of space heating used by Maori. In a more recent case near Kawerau, a greenhouse was located beside a geothermally-sourced lake and heat to the greenhouse was regulated by control of lake level through adjustment of a weir at the lake’s outlet<sup>4</sup>.
- Warm/hot springs – there are many relatively unspoiled springs in remote areas of New Zealand, that can be used for bathing. Transient pools can be created at places like Hot Water Beach for bathing. In many cases water is collected and diverted from springs for use in other applications. While some examples may be on a small scale (e.g. for swimming pool use at the Kamo Springs holiday park) others can involve large quantities of heat and fluid (e.g. for swimming pool use at Morere on the East Coast or at Waikite in the Taupo Volcanic Zone). Given that springs have natural variability in flow and temperature, there is some risk to continuous heat supply in using this method of heat collection.

<sup>4</sup> This greenhouse is no longer operational

- Hot streams – a variation on use of springs is tapping into the flow of hot streams.
- Artesian wells – high temperature wells are normally artesian (i.e. flow under their own pressure e.g. as found in Tokaanu, Taupo, Rotorua or Kawerau), but some low temperature wells are artesian also. The drilling of wells involves a step up in cost and complexity. Wells can be drilled with a range of drilling equipment and have a variety of designs depending on the nature and depth of the resource, and the quantities of heat required. Well costs can vary from (say) \$6,000 for a low cost Taupo domestic well to \$6 million for some wells such as at Kawerau which are linked to the new power station.
- Pumped wells – often wells will tap a relatively shallow aquifer and require pumping. There are many examples of this in the Hauraki Geothermal Region<sup>5</sup> and around Tauranga. Designs are site-specific and pump impellers may be situated at depths of tens of meters. Internationally, there are pumped systems linked into large scale district heating schemes. For local applications the pumps may be operating in 40 - 60°C fluid, but there are examples in the US where pumped systems exist with field temperatures exceeding 150°C.
- Wells with downhole heat exchangers – rather than extract fluids from the ground there has been a recent trend towards use of downhole heat exchangers (DHEs) to extract heat directly from the reservoir. Water (or other fluid) passing down the pipe is heated as it descends but can also cool partially on ascent, especially at shallow depths within the well.

This is an option favoured by some regional councils (e.g. as applied to Rotorua) whose management of the resources involves maintenance of water levels, as water is not taken from the reservoir. Withdrawal of fluid can have a consequential effect on other nearby geothermal-based activities. These DHEs involve a well with downward and upward legs of a closed-circuit pipe. There may be means of encouraging local hot circulation of fluid within the well to maximise heat transfer.

- From other geothermal fluid users – in some cases, wells have capacities in excess of the demands of the primary geothermal fluid users. In these cases costs can be reduced by sharing them across multiple users. The opportunity exists for other consumers in the immediate vicinity to negotiate use of the heat supply. While there is a commonly held belief that there is little opportunity for district heating in New Zealand, there are many existing examples of limited schemes. As an example in Rotorua in 1985 there were a total of 188 domestic wells connected to 1512 separate users i.e. the mini-schemes averaged 8 users per well. One scheme linked 95 domestic users. It is not uncommon for recent Tauranga wells to be linked to 5 or so users.
- Special cases – there are some special cases where wells have been drilled for other purposes, examples being oil and gas wells. Through penetrating to considerable depths, they intersect the natural conductive thermal gradient evident everywhere. In many parts of New Zealand, this gradient averages around 28°C/km of depth. Since some oil and gas wells are drilled to 4 or 5 km in depth, they can intersect temperatures exceeding 160°C which are suitable for a wide range in applications (including electricity generation). There is one known case of an old oil well in New Plymouth that has been used for a number of years for swimming pool heating and as a source of mineral water.

---

<sup>5</sup> The Hauraki Geothermal Region is defined in the Concise Listing of New Zealand geothermal fields (Mongillo *et al* 1984). This corresponds with the Hauraki Rift Zone.

### 2.2.3 Geothermal Fluid Disposal

Because use of geothermal heat often involves taking fluids from below ground the issue of fluid disposal must be addressed. The following paragraphs describe options that are currently practiced in New Zealand (EECA 2007). Note that in the cases of downhole heat exchangers or of closed loop geothermal heat pumps, there are no fluid disposal issues.

- Into waterways or drains – this option is almost universal for low temperature resources. Examples include Waiwera and Parakai near Auckland, most of the warm and hot springs through the Hauraki and Northern Geothermal Regions, and Hanmer and Maruia developments in the South Island. In terms of higher temperature fields, Arataki Honey on the Waiotapu geothermal field disposes of fluids from their well into surface geothermal water, while the Tokaanu public pool rejects its waste geothermal water to the hot Tokaanu stream. A large proportion of water from the Kawerau field is still disposed of to the Tarawera River. Similarly, many of the cascaded uses at Wairakei eventually dispose of their waste to the Waikato River. For Kawerau and Wairakei, river disposal is an historical option and reinjection into shallow and deeper wells has been trialled elsewhere on these fields. Consenting of drain and waterway disposal options will be more difficult in future, especially for the mineralised brines of high temperature fields.
- Onto land – this option can be relatively inexpensive in rural or remote areas, and can be quite acceptable environmentally when the fluid is relatively pure or if the ground is thermally active. The Ohaaki Timber Kilns send their waste water to a surface area designated and consented for such use.
- Into shallow wells – in some cases fluids may not be of sufficient quality to enter surface waterways, in which case a relatively inexpensive option is to use shallow wells. One example of use of shallow wells for disposal is the Esendam greenhouse at Horohoro. This technique, along with disposal into shallow waterways was extensively used at one time in Rotorua. A weakness with the method is that fluids may simply enter shallow groundwater aquifers, potentially causing contamination of groundwater, and may not directly return to the source reservoir. This has led to a restriction on this practice in the Rotorua area with a preference to return fluids to the source reservoir to maintain water levels, or not to extract fluids at all (only heat through downhole heat exchangers).
- Into deep wells – in the case of large scale commercial and industrial applications involving large quantities of hot, highly mineralised fluids, deep reinjection may be a preferable means of disposal. This is, for example, undertaken by Contact Energy for their supply to the Tenon kilns at Tauhara, but deep reinjection is still an exception rather than the rule for direct heat use.
- To adjacent users – in this case, a portion of water containing surplus or low grade heat from one process may be passed to another user. In practice, cascaded use most commonly refers to downstream use of heat from geothermal power stations. However, there are some interesting applications at Kawerau. Norske Skog Tasman (NST) delivers low pressure steam, after generating electricity, to the chemical pulp mill now owned by Carter Holt Harvey Tasman (CHHT). CHHT returns condensate to NST. Elsewhere on the Kawerau site Carter Holt Harvey Woodproducts receives geothermal steam in parallel with NST for their kiln drying operation, but delivers their condensate back to NST for use in their feedwater system. In this case the use of geothermal condensate has a range of positive benefits including offsetting the need for a further take of surface water by the mill.

## 2.2.4 Geothermal Direct Use Applications

There are many examples where geothermal fluids are used directly for heating purposes e.g. directly in swimming pools. There will be other cases where the fluids will be used as a heat transfer media. For example heat exchangers transfer heat from the geothermal fluid to a closed process fluid loop as most geothermal fluids contain a variety of dissolved chemicals because of their elevated temperatures. As these chemicals can be corrosive or troublesome (in terms of scaling) it is advisable in many cases to isolate the geothermal fluid from the process to which the heat is being transferred.

### 2.2.4.1 Heat Exchangers

The main types of exchangers used are either plate heat exchangers (see Figure 2.6) or shell and tube heat exchangers. The main advantage of the plate heat exchanger over the shell and tube design is their superior thermal transfer performance and smaller space requirements, but they are more expensive.



**Figure 2.6.** Plate heat exchanger at the Taupo Prawn farm (Thain et al 2006)

Figure 2.7 shows a common design of down hole heat exchanger (DHE), which is a design to avoid either reducing pressures or fluid levels in an aquifer, or fluid disposal after use. In New Zealand the DHE has generally been used for small domestic applications serving a few households or an industrial application requiring thermal outputs of around 100 to 150 kW<sub>th</sub>. Overseas some DHE installations have outputs of several MW<sub>th</sub>. DHEs have been installed in wells of 200m depth. However, because of the low output of these devices it is generally economic to operate DHEs only in wells of less than 100m.



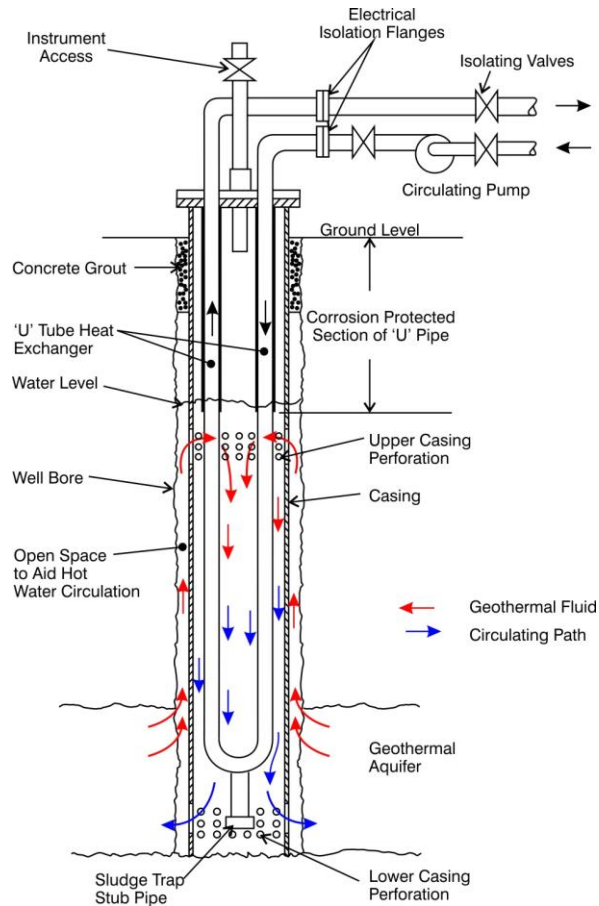

**Figure 2.7.** Typical downhole heat exchanger with promoter tube casing (Thain et al 2006)

Downhole heat exchangers have a significant advantage over conventional geothermal well developments as they allow extraction of heat and leave the fluid undisturbed. This allows heat to be extracted close to sensitive geothermal areas such as the geysers and tourist attractions at Rotorua. From a resource consenting point of view this overcomes the majority of problems associated with geothermal fluid extraction.

### 2.2.4.2 Space cooling

Geothermal space cooling is also possible, either by running heat pumps in reverse or by using vapour-compression, absorption or adsorption chillers.

Figure 2.8 shows the reversible heat pump arrangement used at Dunedin airport, representing a design that could be replicated for large commercial premises. Simple arrangements are possible for smaller applications.

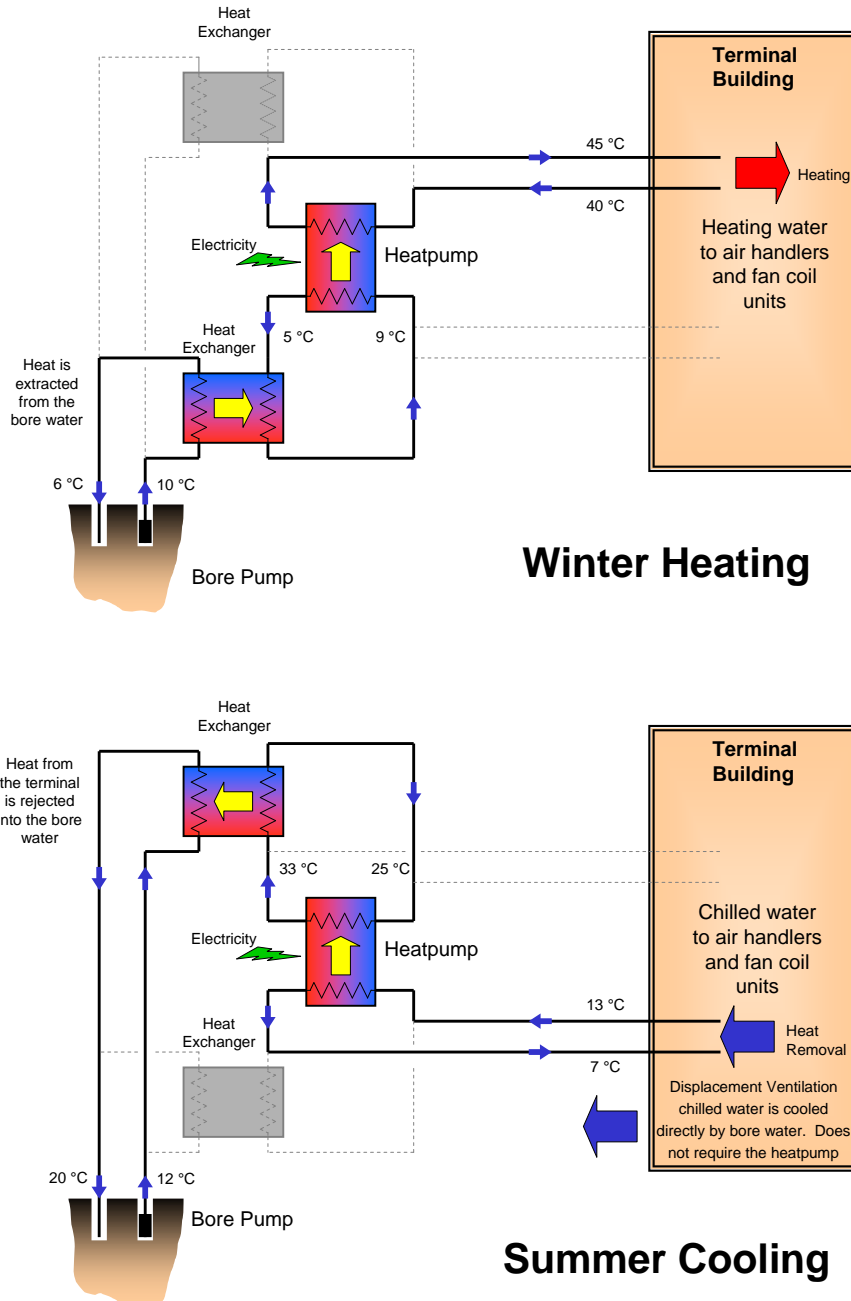

**Figure 2.8.** Dunedin Airport heat pump system showing a cooling circuit mode for summer cooling (Source - MWH)

### 2.2.4.3 Absorption and Adsorption Chilling

The absorption refrigeration cycle is a process by which a cooling effect is produced through the use of two fluids and some heat input, rather than the electrical input required in the more familiar vapour compression (reverse heat pump) cycle. Both vapour compression and absorption refrigeration cycles accomplish the removal of heat through the evaporation of a refrigerant at a low pressure and the rejection of heat through the condensation of the refrigerant at a higher pressure.

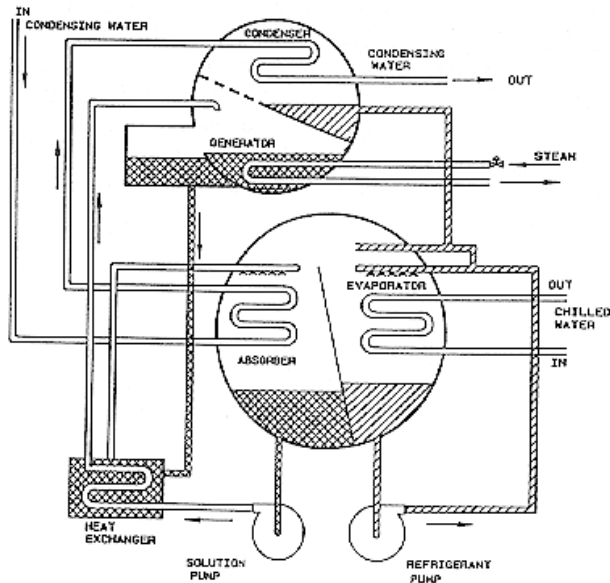

**Figure 2.9.** Schematic diagram of an absorption chiller

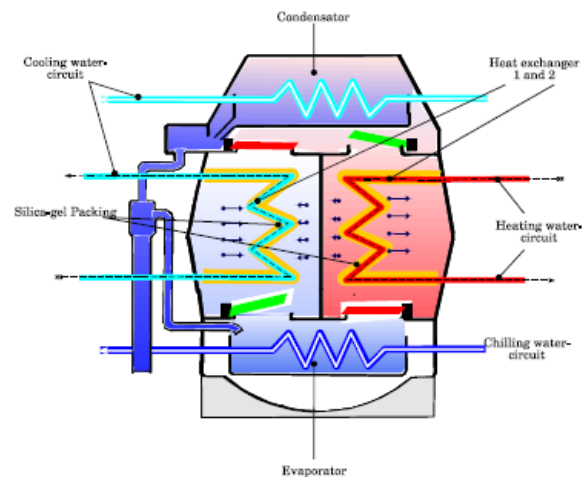

**Figure 2.10** Schematic diagram of an adsorption chiller (Source – GBU)

The method of creating the pressure difference and circulating the refrigerant is the primary difference between the two cycles. The vapour compression cycle employs a mechanical compressor to create the pressure differences necessary to circulate the refrigerant, while in the absorption system, a secondary fluid or absorbent is used to circulate the refrigerant. The absorption cycle generally requires a heat source greater than 100°C which is usually available from high temperature geothermal fields.

Absorption chillers are commercially available today in two basic configurations. For applications above 15°C (primarily air conditioning), the cycle uses lithium bromide as the absorbent and water as the refrigerant. For applications below 15°C, ammonia is used as the refrigerant and water as the absorbent. One unit was installed in a Rotorua hotel in the 1970s but has since been retired.

For a description of a lithium bromide absorption cycle see Appendix 1.

The adsorption chiller also delivers a cooling effect through the use of water, vacuum and a hygroscopic gel. The equipment shown in Figure 2.10 consists of a condensator, a split generator/receiver filled with gel and an evaporator maintained under vacuum. Pneumatic valves switch the supply of tubed water flow in the generator/receiver from heating water to cooling water. Water is fed into the evaporator section where it flashes under vacuum. This flashing process extracts heat from the chilling water circuit. The flashed steam passes through a flap valve into the receiver where it cools and is absorbed in the gel. After a period, pneumatic valves switch the fluid in the tubes from cooling water to heating water supply, which causes the water in the gel to evaporate (regenerating the gel) and then rise into the

condenser section through another flap valve. Cooling water passing through the condenser, condenses the vapour, after which it is returned to the evaporator to continue the cycle.

#### 2.2.4.4 Direct Heat Use in New Zealand

Table 2.2 shows a breakdown of current geothermal direct use in New Zealand.

**Table 2.2:** Assessed Geothermal Direct Heat Use for 2007 (TJ/year) (EECA 2007 – but modified<sup>6</sup>)

Council Regions	Space Heating	Space Cooling	Water Heating	Greenhouse Heating	Fish and Animal Farming	Agricultural Drying	Industrial Process heat	Bathing and Swimming	Other Uses <sup>7</sup>	Total
Northland								6		6
Auckland								65		65
Waikato	13		3	334	271		797	1,321	846	3,585
Bay of Plenty	19				2		5,730	1,196		6,947
Gisborne								0.1		0
Hawke's Bay								3		3
Taranaki								0.2		0
Marlborough	0 <sup>8</sup>									0
Canterbury <sup>9</sup>	15							65		80
West Coast								14		14
Otago <sup>10</sup>	1.7	0.8								3
<b>Total</b>	<b>59</b>	<b>1</b>	<b>3</b>	<b>334</b>	<b>273</b>	<b>0</b>	<b>6,527</b>	<b>2,673</b>	<b>846</b>	<b>10,706</b>

#### 2.2.5 Small-sized Electricity Generation (2 to 30 MW)

Geothermal electricity developments of the order of 2 to 30 MW can directly supply industrial or commercial sites or feed into a local network, and so can be considered distributed generation. While many New Zealand geothermal fields have development potential considerably greater than 30MW, a number of commercial developments undertaken to date have been of this size.

Common plant arrangements include:

- Back pressure turbines – these are conventional steam turbines (directly coupled to generators) that receive steam at one pressure and vent it at atmospheric pressure or higher, perhaps for use elsewhere in industrial or heating processes. Because the

<sup>6</sup> Assessment now includes allowance for known heat pump use in Canterbury and Otago

<sup>7</sup> “Other uses” are dominated by a brine supply at Wairakei to a tourism operator to recreate geysers and silica terraces.

<sup>8</sup> Although this value is shown as 0, there is actually a small known use associated with domestic heating

<sup>9</sup> This table now includes an allowance for 50TJ/year of heat pump applications associated with Christchurch City Council operations. The split between space heating and pool use is approximate.

<sup>10</sup> This table now includes an allowance for the Dunedin airport geothermal heat pump system.

steam is not condensed there is no problem associated with accumulation of the small amount of non-condensable gas (mainly CO<sub>2</sub>) present in geothermal steam. Examples include the turbine within the Kawerau Norske Skog Tasman plant and some turbines at Wairakei.

- Condensing steam turbines – this is an efficiency improvement on the back pressure turbine in that more energy can be extracted from the same incoming steam by causing it to vent into a vacuum. The vacuum is normally created by spraying cold water into a condenser below the turbine. Frequently this cold water is sourced from a recirculation system involving cooling towers and pumps. To prevent a build up of non-condensable gas, a gas extraction system must be installed. Examples include Wairakei Low Pressure and Mixed Pressure turbines, Ohaaki and Poihipi stations, and the new Kawerau station.
- Binary cycle plant (Organic Rankine Cycle plant) – this is a variation on a condensing steam turbine system and is normally used to generate electricity from fluids of lower temperature. Instead of using steam in the cycle, this uses a low boiling point organic fluid (a refrigerant) whose vapour passes through a turbine (normally of radial inflow design). Heat exchangers are required to transfer heat from geothermal water or steam to boil the organic fluid. Non-condensable gases can simply be vented to atmosphere (or could be reinjected) because the condensed steam is not under a vacuum. Examples include the Ngawha and Kawerau plants, and plant at Wairakei linked to the reinjection system.
- Kalina cycle plant – a recent variation on the binary cycle plant which uses a varying mixture of secondary fluids (ammonia and water) to maximise heat transfer characteristics. No examples exist in New Zealand yet, but there are operating geothermal Kalina plants in Iceland and Germany.
- Hybrid plant – a common variation applied to high temperature resources is to use a back pressure turbine venting just above atmospheric pressure with a binary cycle plant acting to condense the steam. This can be particularly efficient where there is a high non-condensable gas concentration but is generally competitive across a range of conditions. Examples include Mokai and Rotokawa.

Table 2.3 shows all developments in the 2 to 30 MW size range in New Zealand.

From the table, it is evident that almost all of these developments fall within conventional definitions of distributed generation. Two possible exceptions are the two efficiency improvements at Wairakei where electricity is fed directly into the national grid along with the rest of Wairakei's generation, though they are still good examples of distributed generation technologies.

**Table 2.3.** Small (2 to 30 MW) Geothermal Generators Installed in New Zealand

<b>Project</b>	<b>Developer</b>	<b>Purpose</b>	<b>Description</b>
Kawerau Back Pressure Turbine, Commissioned 1966, 10 MW Replaced 2004	Initially Tasman Pulp and Paper Company (now Norske Skog Tasman)	On-site generation and pressure reduction	A portion of geothermal steam otherwise directed to process can be fed to the turbine. Exhausted steam is used in other processes
Kawerau TG1 Binary plant, Commissioned 1989, 2.4 MW total	Bay of Plenty Electricity	Local network supply and low priced generation	Ormat binary cycle units. This proved the Ormat binary plant in New Zealand
Kawerau TG2 Binary plant, Commissioned 1993 3.5 MW total	Bay of Plenty Electricity	Local network supply and low priced generation	Ormat binary cycle units
Wairakei Back Pressure Turbine Commissioned 1996, 5 MW	Electricity Corporation of New Zealand (now Contact)	Provided an efficiency gain through replacement of back pressure valves	A low-cost second-hand refurbished steam turbo-generator imported from South Africa
Rotokawa, Commissioned 1997, 29 MW, Expanded to 35 MW in 2003	TransAlta (now Mighty River Power) with Tauhara North No 2 Trust	Electricity was fed directly into the Taupo network, plant gave TransAlta initial experience with geothermal	Ormat hybrid power plant (steam to back pressure turbine, vented steam and brine to separate Ormat units). Expansion resulted from enthalpy changes enabling more energy to be extracted from the same fluid
Ngawha Commissioned 1998, 10 MW, Currently being expanded to 25 MW	Top Energy	Local network supply and low priced generation	Ormat binary cycle units
Kawerau Back Pressure Turbine Replacement, Commissioned 2004 8 MW	Norske Skog Tasman	See the first project above – this is integral to the process	Unit based on ex-navy turbines supplied by GDA
Wairakei Binary, Commissioned 2005, 14.4 MW	Contact Energy	Essentially an efficiency measure extracting heat from water intended for reinjection	Ormat binary cycle units. Electricity is fed into the Transpower substation

Two developments not listed in the table are the Mokai and Poihipi developments, each initially of 55 MW, and so outside the definition of small generation.

- Mokai was intended as a merchant plant selling electricity into the grid, but some thought was given to a portion of its generation being used locally.
- Poihipi was intended for grid connection,. Its initial developers were the Geotherm Group in joint venture with Mercury Energy. Mercury Energy was the supply authority selling into the Auckland market south of the Harbour Bridge, but electricity law changes forced it to sell its generation assets to become only a network owner.

Arguably, this was generation intended for a local market rather than the national market.

## 2.2.6 Mini-sized Electricity Generation (200 kW to 2 MW)

Generally the trend with electricity generation has been to move to larger sized developments. Recently though, manufacturers have recognised the benefits of smaller-scale development. Such mini stations can:

- Match the potential of an individual existing well (or wells)
- Match the potential of large boiling springs
- Match local demands, including for remote communities
- Fit neatly in with some existing geothermal heating plant for off-heating season application
- Be adapted from other high volume commercial equipment for cost savings.

The design, and range of options, for mini-sized plant is similar to large and small scale plant, though the most recent focus has been on binary (Organic Rankine) cycle plant.

Several manufacturers are now producing binary cycle plant of approximately 250 kW capacity, with some looking to establish a standard 1 MW module. These fill the role of a standard small-scale modular geothermal electricity generation facility for distributed energy applications. The table below shows some recent overseas installations.

**Table 2.4.** Recent Examples of Approximately 250 kW Capacity Geothermal Stations

Project	Manufacturer	Purpose	Description
Rogner Bad Blumau, Austria, 250 kW gross, Commissioned 2001	Ormat Industries of Israel	First private sector power development in Austria, feeds local network with electricity and heat for an Austrian spa facility	Binary cycle plant, Uses 30 l/s of 110°C water, water exits at 85°C for local district heating use, Air-cooled
Neustadt-Glewe, NE Germany, 210 kW gross, Commissioned 2003	Bewag Aktiengesellschaft & Co of Berlin, Germany	Generates electricity for local network in periods of low demand for a geothermal district heating scheme	Binary cycle plant, Uses 98°C water, Air-cooled, Total power plant capital cost excluding fluid collection was €950,000
Japan, 250 kW gross, Commissioned 2005	Fuji Electric of Japan	Demonstrates the technology to enable design refinement, with electricity sold to a local resort	Binary cycle plant, Uses 130°C water, Air cooled
Chena, Alaska, USA, 2x250 kW gross, Commissioned 2006	UTC Power of USA	Generates baseload electricity for an off-grid tourist site	Binary cycle plant, Uses 73°C water, Either air-cooled or water cooled depending on the season (arctic conditions), Total project cost (incl. many ancillary services) was US\$2m

**Figure 2.11** Montage of recent geothermal power developments of approximately 250 kW



Rogner Bad Blumau 250 kW, Austria



Chena 2 x 250 kW, Alaska, USA



Geothermal Power Station Neustadt-Glewe

Above – Neustadt-Glewe 210 kW site layout, Germany



Left – Neustadt-Glewe 210 kW ORC unit with container walls removed



## **2.3 Exceptional Large Scale Developments**

Because site loads are normally quite small, distributed energy is normally thought of in these terms. However, the availability of geothermal energy has occasionally attracted significant loads to take advantage of the energy source.

In New Zealand, the best example of a geothermal field attracting a major user is the Tasman Pulp and Paper Mill at Kawerau. This site is associated with supply of nearly half of the direct use of geothermal energy in New Zealand, and about half of the direct use of geothermal energy at industrial sites globally. Kawerau geothermal developments illustrate some interesting applications:

- Process steam supply: Geothermal steam is mainly used for heating purposes, though some is used for electricity generation within the mill.
- Local electricity generation for the network: Because the mill site sits within the Bay of Plenty Electricity (BOPE) supply area, BOPE invested in small generation units taking advantage of the hot geothermal water otherwise being disposed of to air and to the local Tarawera River. For many years, electricity distribution companies were prohibited from investing in generation from many sources including geothermal energy but legislative amendments are now freeing up networks to invest.
- Large embedded electricity generation: Currently, Mighty River Power is in the process of building a 90MW geothermal power station at Kawerau. While the station will be connected to the national grid, effectively all of the generation can be absorbed by the Kawerau mills and could be covered by contracts to this effect. As such, this can be thought of as one of the largest distributed generation projects in New Zealand.

Another example where a significant load has been attracted to a geothermal field is the dairy factory at Reporoa. This factory could potentially have used the geothermal energy for heating or embedded generation. In practice, exploration and development of the field was slow and, eventually interest in development was overtaken by concerns for possible disturbance of nearby protected geothermal fields which resulted in effective prohibition of the Reporoa field from development.

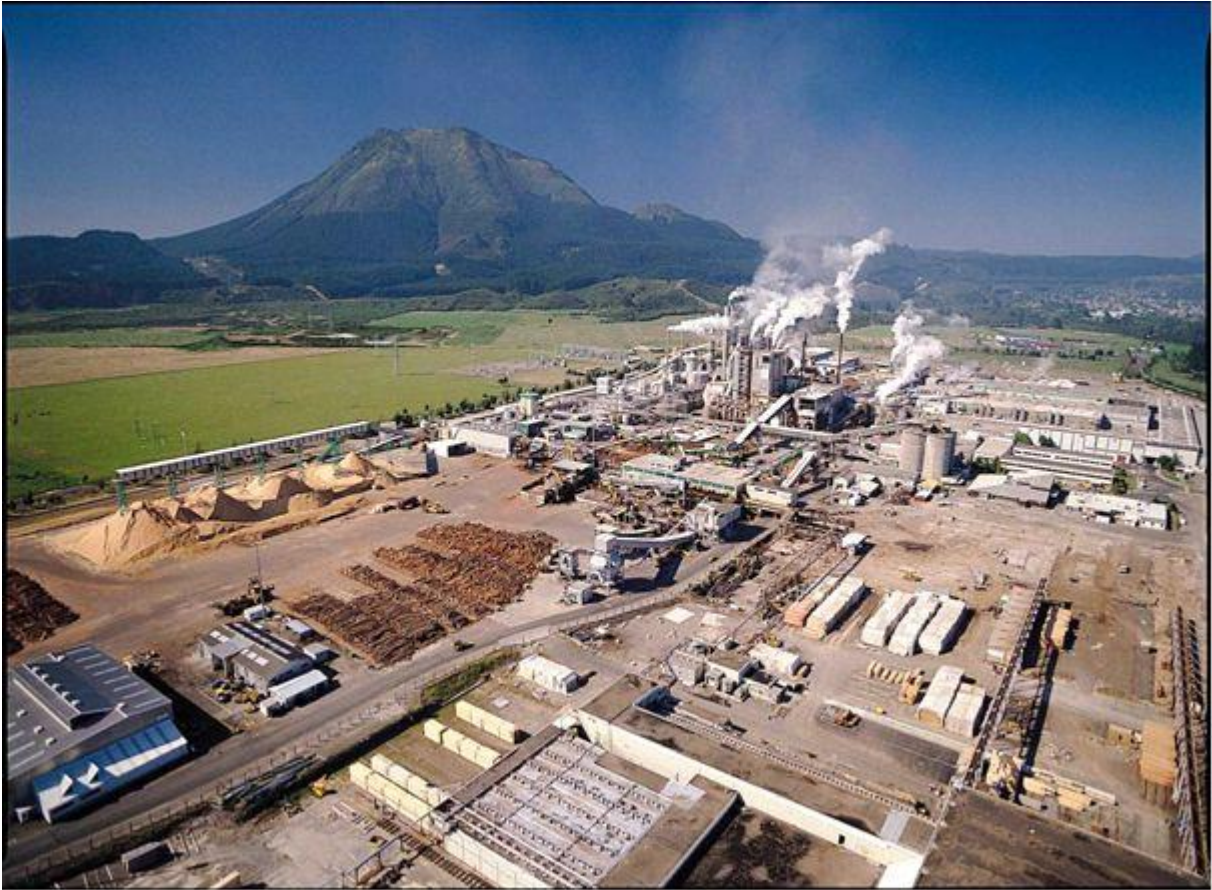

**Photograph 2:** Kawerau mill site, Bay of Plenty region. This is one of the largest geothermal direct heat uses in the world (approximately 5,300 TJ/year). Use is spread over three separate owners with supply from a fourth party.

# 3 Geothermal Resource Requirements and Areas of Technology Applicability

## 3.1 Lindal Chart Relating Temperature and Application

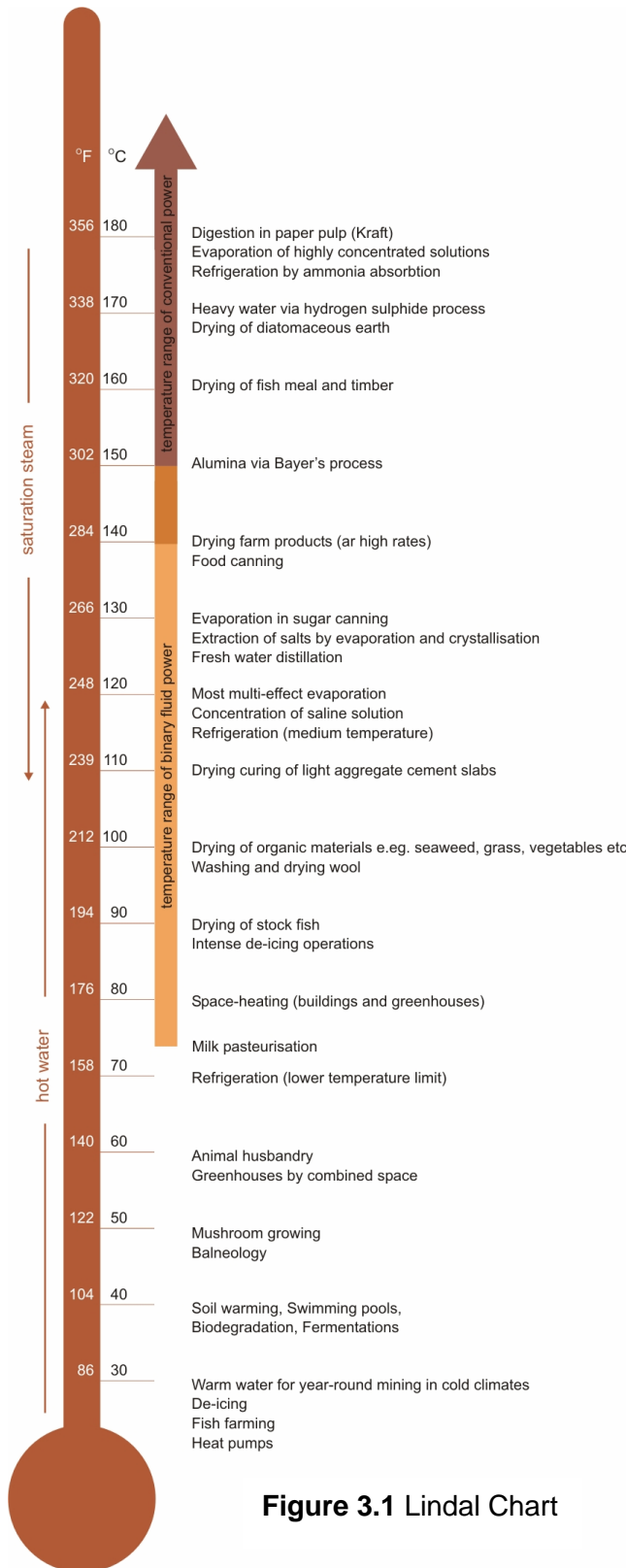

Figure 3.1 Lindal Chart

Figure 3.1 shows typical heat applications for a range of temperatures, including heat required to generate electricity.

Many simple heating processes require only relatively low temperatures, with 50 or 60°C being useful for a wide range of applications.

The chart indicates that some industrial-type applications (including power generation) could be achieved for water temperatures of around 70°C, but these represent extreme cases, and 95 – 100°C (or more) is preferable.

Keeping in mind these useful temperatures, it is now possible to look at areas where the various technologies can be applied.

## 3.2 Geothermal Heat Pumps

Theoretically, heat pumps can be used anywhere, but much work has to be done to clarify locations best suited to such applications in New Zealand. In terms of ground-source heat pumps, the rate of heat transfer between the loop of pipe and the surrounding ground is determined by the conductivity of the ground. Favourable conditions require sandy ground, water-saturated with high solar radiation, allowing extraction of 35 – 40 W/m<sup>2</sup>, while the least favourable conditions would include pumice soils (as found in typical geothermal areas) and well drained stony ground in shaded areas, allowing heat extraction rates of only 8-12 W/m<sup>2</sup>. There have been two recent examples of ground loops installed in the Hamilton loams. One of these is a demonstration facility by Mighty River Power at their own offices in Hamilton.

There are many surface waters, such as

rivers, lakes, ponds or the sea that can act as heat sources for heat pumps. Well water was used for many years in a Hamilton commercial application and shallow wells immediately beside Lake Taupo have been used recently. Another application in Blenheim uses irrigation water as the heat source, which could be an option for many farmers whose homes are located near canals or irrigation ditches that are in continuous use. Sea water is a heat source not currently used in New Zealand but with considerable potential. Any harbour-side development could tap into this, whether it is for large scale commercial developments or canal-based luxury holiday homes.

**Figure 3.2.** A Montage of Some Surface Waters that could be Heat Sources or Sinks (note the proximity of large commercial or domestic heating loads to these waters)



Lake Whakatipu beside Queenstown



Waitemata Harbour beside Auckland



© Tom Dempsey / Photoseek.com

Wellington Harbour



Pauanui Waterways Canal Housing



Waikato River through Hamilton

### 3.3 Water for Bathing, Aquaculture or Low Temperature Heating

#### 3.3.1 Potential Engineered Systems

There is a natural temperature gradient in the Earth's crust. Outside of the main geothermal areas the gradient is usually between 27-33°C/km of depth. With mean ambient air temperature around 12°C, this suggests that a temperature of 45°C could be reached at a depth of 1.0-1.2km or 60°C could be reached at 1.5-1.8km throughout much of New Zealand. This temperature range covers the temperatures of most major New Zealand spa and hot pool facilities. However geologists should be consulted for the likely nature of any reservoir that might be encountered in specific locations.

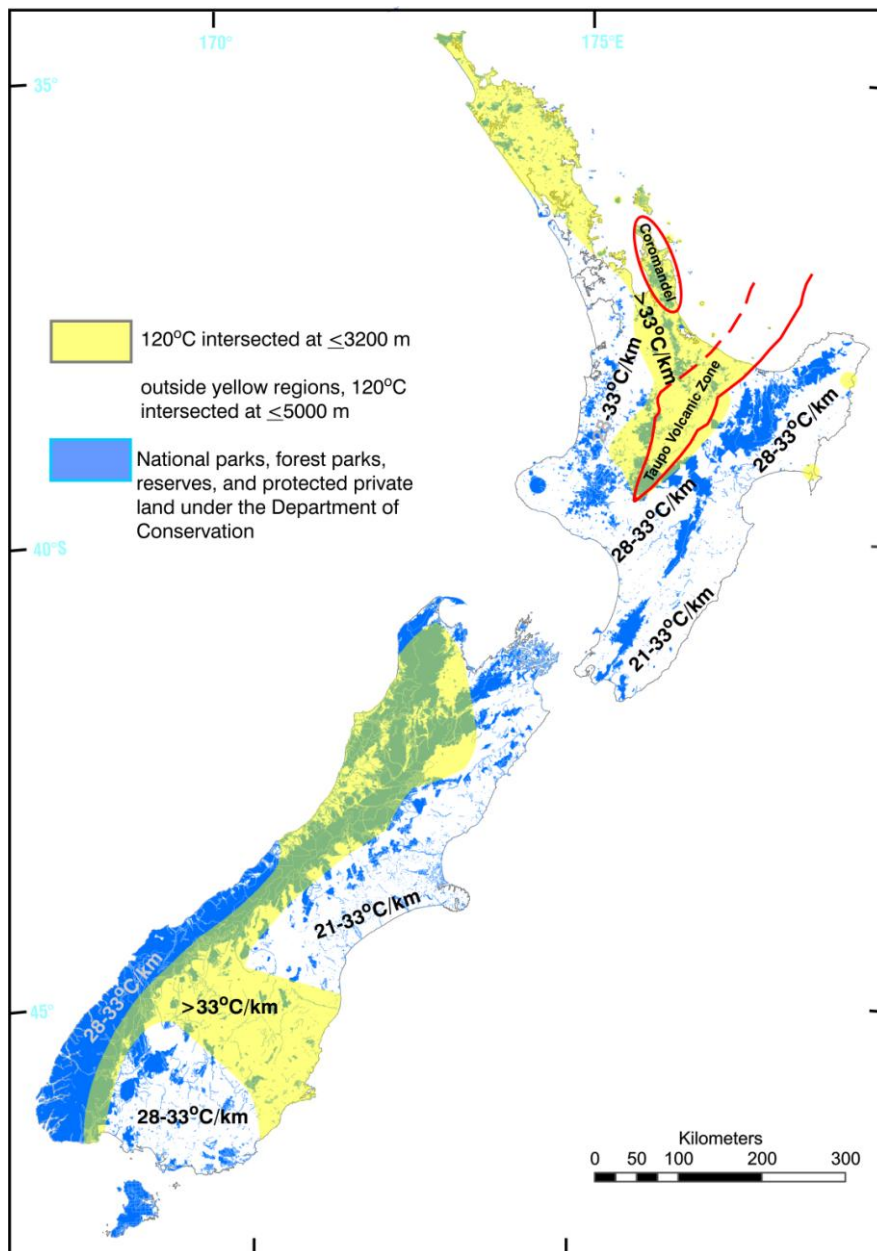

**Figure 3.3.** Areas and associated thermal gradients using shallow and deep-seated conductive heat (Reyes 2007).

This section covers engineering a geothermal system where there is no indication of an abnormal geothermal gradient at a site. A simple economic model is developed in section 4 of this report based on a swimming pool/spa complex. This shows the potential attractiveness of accessing deep warm water at an appropriate site chosen by a developer.

A significant source of material for Figure 3.3 was derived from a review of bottom-hole temperatures in oil and gas wells as shown in Figure 3.4.

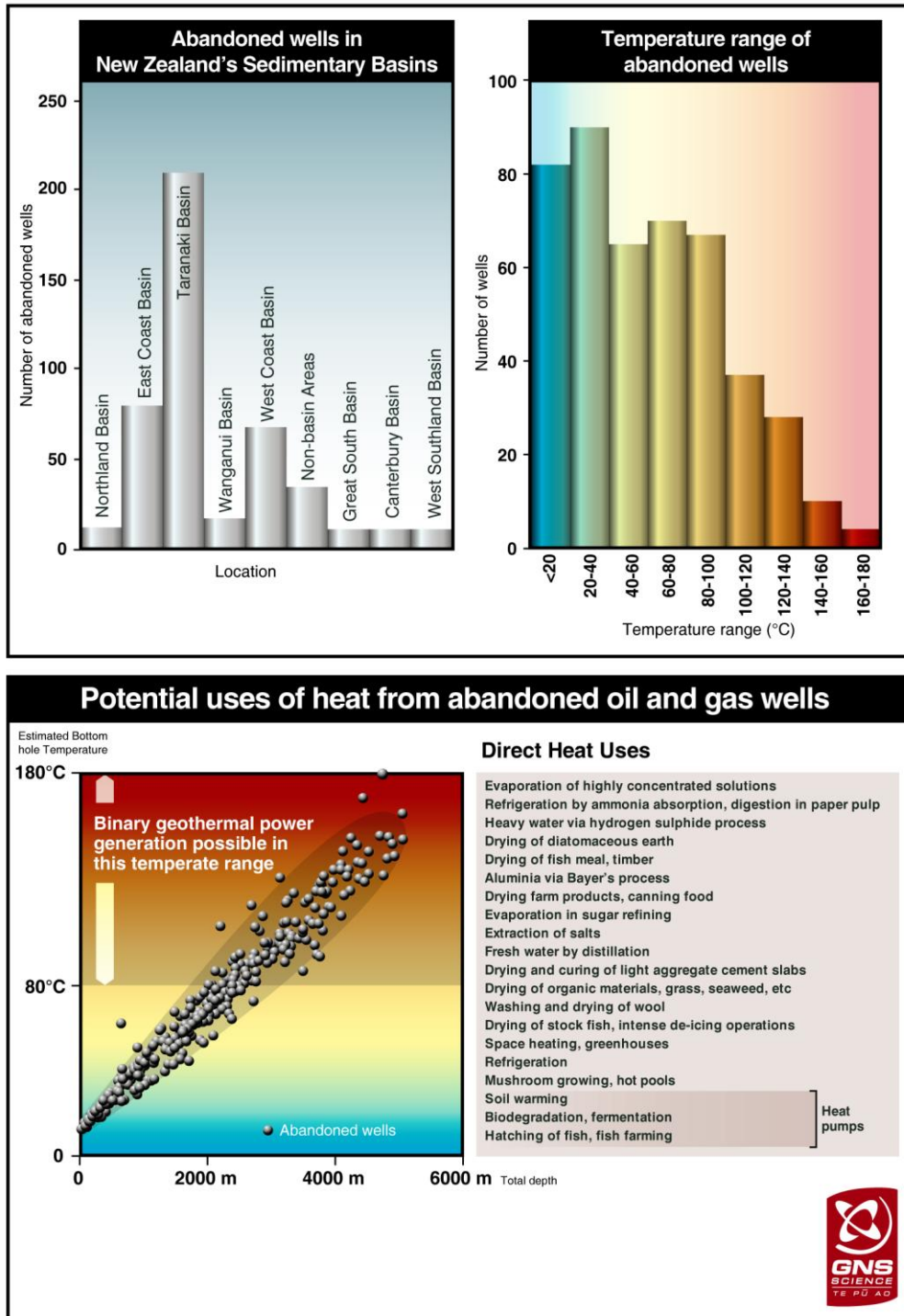
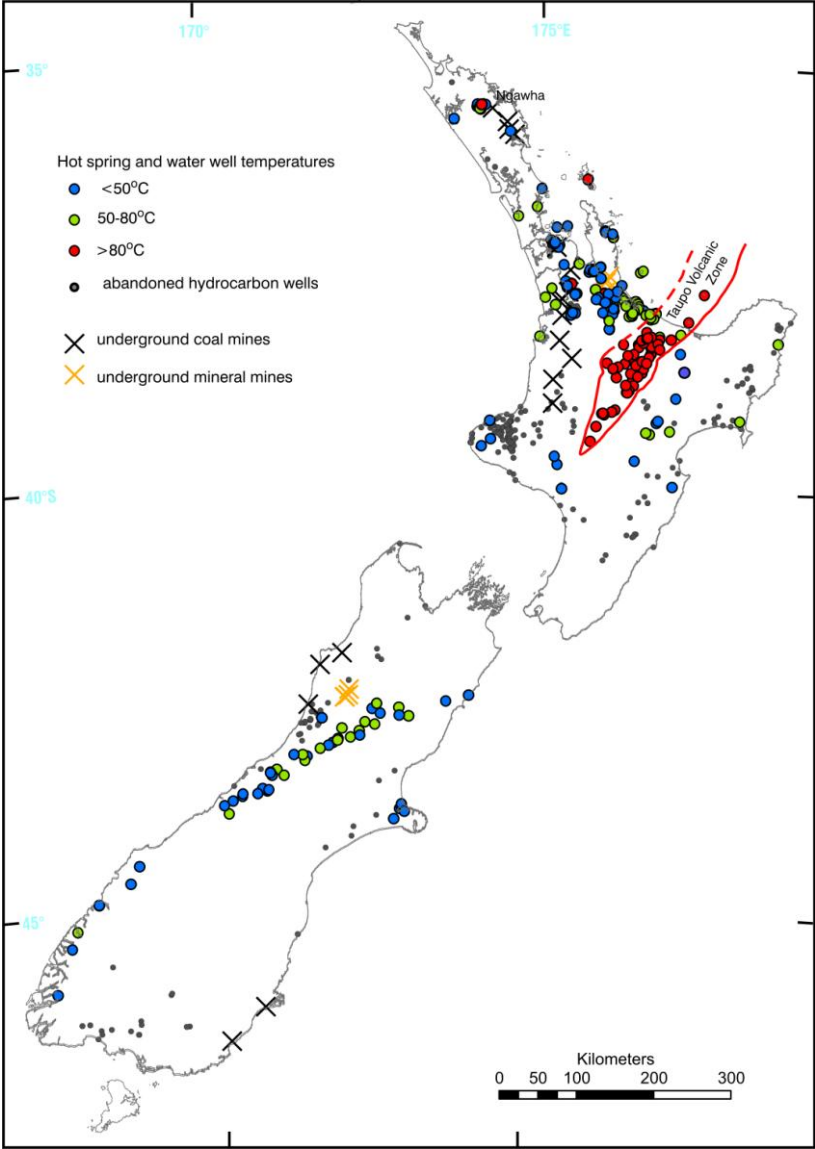

Figure 3.4. Indications of natural thermal gradients around New Zealand based on deep abandoned oil and gas wells (Reyes 2007)

In practice there may be opportunities to save on costs of engineered systems where there are existing abandoned oil and gas wells. Drilling records may show useful deep aquifers that can be tapped. The well could be recompleted to seal off abandoned hydrocarbon layers and to give access to suitable elevated temperature water reservoirs. The Taranaki Mineral Pools in New Plymouth are an example of thermal pools based on an abandoned oil and gas well.

### 3.3.2 Conventional Geothermal Systems

The following map shows many locations around New Zealand with elevated spring and near-surface water temperatures. Any of these locations has potential for use for bathing, aquaculture or low temperature heating.



**Figure 3.5.** Location map of some geothermal sources including hot spring systems and their maximum surface discharge temperatures, abandoned onshore hydrocarbon wells and abandoned flooded underground coal and mineral mines (Reyes, 2007).

The presence of springs is an indicator of more extensive aquifers which could be tapped by drilling. Thus there will be an area around many of these springs that could be developed. Generally the extent of these aquifers is not well defined so potential developers should contact their local councils, GNS Science and local drillers in the first instance.

### 3.4 Areas for Higher Temperature Applications (Including Electricity Generation)

New Zealand geothermal locations are sharply divided between areas of hot springs less than 70°C, and the high temperature fields of the Taupo Volcanic Zone and Ngawha. A range of high temperature applications could be developed on the high temperature fields, most of which have reservoir temperatures in excess of 200°C, though surface springs themselves will still be limited to just under 100°C.

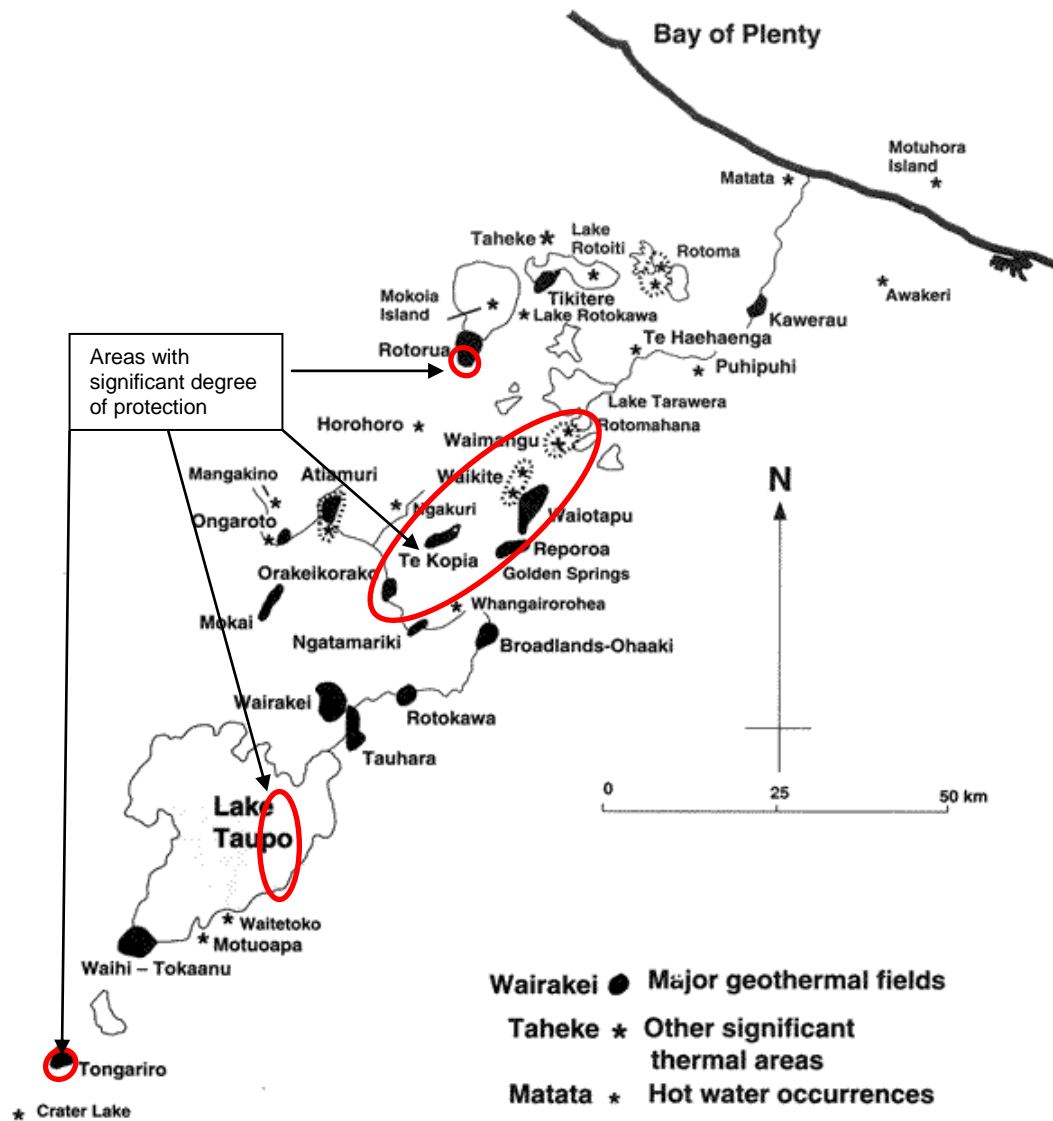

Figure 3.6. Major high temperature fields in New Zealand (excluding Ngawha in Northland near Kaikohe)

Figure 3.6 shows some fields that have been accorded a high degree of protection by regional councils. However this protection generally will not extend to use of surface waters as these will not alter deep reservoir pressures. There are already examples of developments on protected fields taking advantage of surface springs e.g. hotel heating at Orakei Korako, and pool heating at Waikite. Limited drilling and development is allowed on these fields, with one existing development being a heat supply for honey production at Waiotapu.

Given that binary cycle plant can use 95°C fluid for electricity generation some development may be possible on boiling springs, where this does not conflict with existing operations, for example tourism.



## 4 Attractiveness of the Investment

### 4.1 Nature of Geothermal Investment

All geothermal investment is characterised by high capital cost offset by lower fuel costs relative to fossil-fuelled competition. This is typical of renewable energy investments and requires a long-term view to be taken by the investor. Generally, the plant installed will have a long life. When investment is considered over the life of the option, then geothermal investments in distributed energy can be an attractive option.

The following section sets out approximate costs associated with the various enabling technologies discussed earlier. If potential applications fall into classes that are close to being viable then it could be worth investigating them specifically to see how the local environment and specific demands may improve the attractiveness of the project.

### 4.2 Geothermal Heat Pumps

Several reports have been published recently setting out approximate costs for geothermal heat pumps. Readers are specifically directed to the “Assessment of Possible Renewable Energy Targets – Direct Use: Geothermal” (EECA 2007).

The broad conclusion of that report is that for large domestic heating loads and for a wide range of commercial premises, geothermal heat pumps are an attractive option for providing heat when compared with a range of competing energy sources.

Geothermal heat pumps tend to have a higher capital cost particularly at the smaller sizes when compared with other forms of heating (see Tables 4.1 and 4.2). However, they do have the advantage of very competitive operating costs (electricity costs that have been minimised by the high COP). Their performance is less affected by the outside temperatures, in comparison to air source heat pumps, and they tend to have higher COPs. The latest advice on maintenance costs is that these are expected to be of the order of 2.5% of capital cost annually.

**Table 4.1.** Example Costs of Heat Pump Systems Including a Comparison with Air Source Heat Pumps

Heating Capacity	6kW <sup>11</sup>	20kW <sup>12</sup>	726kW <sup>13</sup>	20kW air source heat pump <sup>14</sup>
Capital Cost (NZ\$)	Heat pump \$6-7,500 Ground loop \$2,300 <sup>15</sup> Underfloor/hot water system \$2,500 Total cost ~ \$12,000	Total cost ~ \$24,000	Total cost ~ \$488,000	Total cost ~ \$19,000
COP	4	5	4.3	3.7

<sup>11</sup> Example provided by Ian Thain in the GNS report “A Practical Guide to Exploiting Low Temperature Geothermal Resources”

<sup>12</sup> Example provided by Phil Davis of Warmfloor Heating

<sup>13</sup> Example from Wang, Z and Wang, H (July 2006) “Economic Analysis of Water Source Heat Pump System” in *Proceedings of the 7<sup>th</sup> Asian Geothermal Symposium*

<sup>14</sup> Example provided by Phil Davis

<sup>15</sup> Assuming favourable sandy moist soil

Heating costs from geothermal heat pumps are competitive with other forms of heating particularly at the larger sizes. These are shown in Table 4.2. These heat costs would reduce if load factor was higher, for example through heat supply to a swimming pool in summer.

**Table 4.2.** Generic Heating Costs (includes all capital cost, operating cost and fuel cost)

Project	Size	Load factor	Heating Cost <sup>16</sup>			
			5% WACC <sup>17</sup>		10% WACC	
			No CO <sub>2</sub> cost	\$25/t CO <sub>2</sub> cost <sup>18</sup>	No CO <sub>2</sub> cost	\$25/t CO <sub>2</sub> cost
	kW		c/kWh	c/kWh	c/kWh	c/kWh
Geo Heat pump, 6 kW heating, average house	6	0.10	28.6	29.5	40.0	40.9
Geo Heat pump, 20 kW heating, large house	20	0.12	15.9	16.8	21.4	22.4
Geo Heat pump, 726 kW heating, commercial	726	0.29	6.3	7.3	7.6	8.6
Geo Heat pump, 726 kW heating, industrial	726	0.40	4.2	5.2	5.2	6.1
Geo Heat pump, 726 kW heating, school	726	0.16	8.4	9.4	10.8	11.8
Heat pump, (air source) 6 kW heating, average house	6	0.10	13.6	14.6	16.5	17.4
Heat pump (air source), 20 kW heating, large house	20	0.12	15.0	16.0	19.5	20.4
Pellet burner, 6 kW, average house <sup>19</sup>	6	0.10	18.9	18.9	23.2	23.2
Pellet burner 13 kW, Auckland large house	13	0.12	16.8	16.8	20.3	20.3
Pellet burner, 1000 kW heating, School	1000	0.16	7.5	7.5	8.5	8.5
Gas fire, 6 kW, average house	6	0.10	22.8	24.1	26.6	27.9
Geo Heat Pump, (Blenheim house) 18 kW	18	0.22	14.7	15.7	18.4	19.4
Electric resistance heater <sup>20</sup> , 6kW	6	0.10	25.9	26.8	26.1	27.1

In Table 4.2 at an average house load of 6 kW peak heating capacity<sup>21</sup>, geothermal heat pumps and gas heating appear unattractive compared to the use of pellet burners or air source heat pumps. However for large houses (with water heating), geothermal heat pumps approach the unit cost of air source heat pumps. In circumstances where the price of electricity is high, then the better coefficient of performance of the geothermal heat pump may make that option preferable to all other options.

The Blenheim house is based on a specific case where the costs and usage are known. In this case the heating load factor was nearly double that assumed for the other generic cases. The owner has invested for comfort as well as efficiency.

For larger commercial loads, economies of scale and the high coefficient of performance of the geothermal heat pumps combine to make use of this heating option attractive. The resulting unit cost is below that of a unit of electricity, even without adding the capital cost of resistance heaters. For example, a geothermal heat pump option was recently installed by

<sup>16</sup> For the generic cases electricity prices used are the variable component of average prices for New Zealand. In the case of the school a commercial electricity tariff was used. Analysis was performed with a 30% tax rate and is on a post tax real basis

<sup>17</sup> WACC is the Weighted Average Cost of Capital, in this case on a post tax real basis.

<sup>18</sup> The increased cost associated with carbon is a pass through cost and has been calculated according to the fuel being used. In the case of electricity pricing it has been assumed that gas is the marginal fuel and it has been burnt in a combined cycle gas turbine at 50% efficiency. No other costs have been included.

<sup>19</sup> Pellet burners tend to have a higher output than 6 kW, the smallest being around 8 kW (on which the pricing has been based).

<sup>20</sup> Resistance heater costs are based on 3 x 2kW heaters replaced every 4 years.

<sup>21</sup> While an exact average domestic peak heating capacity is not available, an estimate of 6kW is considered by BRANZ to be appropriate.

the Dunedin Airport developers who selected a space heating and cooling system based on use of shallow ground water taken from local aquifers.

### 4.3 Low Temperature Heating

#### 4.3.1 Potential Engineered Systems

In this report, we have discussed the option of developing wells outside the traditional areas simply taking advantage of the heat available through natural thermal gradients. In some cases, recompletion of an existing abandoned oil and gas well to focus production on a water aquifer may be an option, since some of these wells have temperatures exceeding 150°C. This option has not been costed as it would be well-specific.

A further variation on this is drilling wells to depths of between 1 and 1.8 km to tap temperatures of between 45 and 60 °C, for bathing or other low temperature uses. This type of well could have a radically different (simpler and lower cost) design to conventional geothermal wells that require progressive drilling and multiple casings, essentially being a deep ground water well. While costing of such a design has not been undertaken, one drilling company representative considers the cost for a 6 – 8” diameter well could be of the order of NZ\$0.5million to NZ\$1.0million i.e approximately NZ\$500/m including mobilisation and demobilisation costs. Such a well could have an output measured in the tens of kilograms per second, whereas, for example, the total water take at 52°C for the Hanmer Springs pool complex is only 260,000m<sup>3</sup>/year (averaging 8.2kg/s). If water abstracted is of a suitable quality, it could be used after useful heat extraction, for other purposes, such as irrigation or domestic supplies. Otherwise a second injector well might be required.

The following table sets out some options and equivalent annualised cost. Annual operations and maintenance is taken as 2.5% of the capital cost, life is assumed to be 30 years, and the Weighted Average Cost of Capital (WACC) is post tax real.

**Table 4.3** Cost of a 45 to 60°C Heat Supply Outside Traditional Geothermal Areas

Option	Capital cost (\$000s) <sup>22</sup>	Annual operations cost (\$000s)	Annualised energy cost 5% WACC (\$000s)	Annualised energy cost 10% WACC (\$000s)
45°C supply, 27°C/km, 1.2km deep well	600	15	64	98
45°C supply, 33°C/km, 1.0km deep well	500	13	53	82
60°C supply, 27°C/km, 1.8km deep well	900	23	95	147
60°C supply, 33°C/km, 1.5km deep well	750	19	79	123

A developer would have to consider their specific business case to determine whether these costs would be viable. For comparison purposes though, the relatively remote but successful Hanmer Springs complex attracts around 500,000 visitors per year (White 2007) with a basic adult entry ticket price of \$12 and a range of supplementary income opportunities through food sales, private spa treatments etc. Thus revenue streams can be in the multi-millions of dollars. Could business cases be developed for natural spas on the slopes of Mt Taranaki or the Port Hills as examples?

<sup>22</sup> Assumes single well with artesian flow



**Photograph 3** Mt Taranaki from Pouakai Tarns (photo courtesy of James Osmond)

### **4.3.2 Conventional Geothermal Developments**

Typical arrangements for traditional direct use of geothermal energy have been outlined in previous chapters of this report. There are some low cost development options that simply involve the channelling of hot spring or stream water to a swimming pool or similar application, for which costs are not discussed here. The following discussion of costs is based on the next level up in terms of cost where wells of some sort will be required.

Geothermal wells have risks and costs which cannot be fully determined until the well is completed. Nearby wells will give an indication, if information is available. As a ball park figure, domestic and small commercial wells of around 100mm diameter can cost of the order of \$110/m, with typical depths (depending on location) being in the range 100 to 500 m for traditional geothermal development areas (e.g. Taupo, Rotorua, Tauranga). Production from these wells is site dependant but is typically enough for the heating needs of several homes and potentially many more.

Unit costs for a range of heating applications have been calculated. The results are shown in Figure 4.1, based on the cost inputs shown in Table 4.4. Capital and operating costs have been divided by the energy provided to derive unit costs in terms of c/kWh. This is compared with the variable component of retail electricity price as a simple means of determining commercial viability (strictly, capital costs of resistance heaters should be added to the comparative electricity price, making the comparison more favourable for geothermal).

**Table 4.4** Costs Associated with Traditional Geothermal Heat Options

Application	Capital Cost (\$000s)	Operating Cost (\$000s)	Unit Cost at 5% WACC (c/kWh)	Unit Cost at 10% WACC (c/kWh)
Average House	9	0.09	15.5	23.2
Large House	14	0.14	10.3	15.4
Hotel	44	0.44	1.6	2.5
School	514	5.14	3.9	5.8

Analysis has been carried out for Weighted Average Cost of Capital of 5% and 10%. A 10% post tax real analysis is typical of what a commercial company might consider. At the domestic level there is a case for using 5%, being closer to the return that would normally be expected for an individual with investment funds.

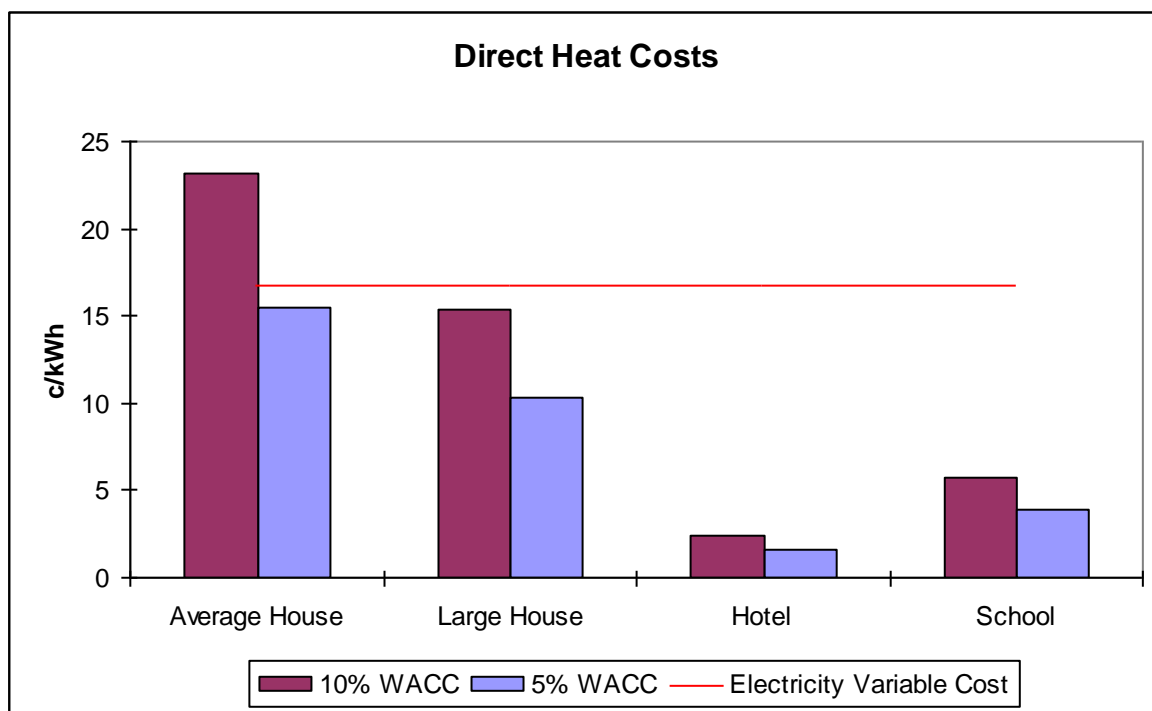

**Figure 4.1.** Comparison of conventional geothermal direct heat unit costs (in terms of cents per kWh of heat produced) with current variable electricity price

Figure 4.1 shows that for all indicative sizes of houses (from average to large) direct use of wells for water and space heating can be an attractive option. For hotels and schools (and also for a wide range of commercial applications) in the thermal regions, direct heating is an option.

A further comparison with Table 4.2 shows that these conventional direct heat options are competitive with a wide range of other heating options, with the exception of the average house for which air-source heat pumps appear preferable.

#### **4.4 Industrial Heat Supply from High Temperature Fields**

The following graph is taken from the EECA report “Assessment of Possible Renewable Energy Targets – Direct Use: Geothermal” (EECA 2007) and compares the delivered heat cost of various energy sources with two geothermal heat supply options. The delivered heat

cost is the total heat cost, including fuel costs, annualised boiler and other heat plant costs (for the geothermal development this includes wells, pipes, separators, etc), and operating costs.

The options considered are a greenfield option and an option for a heat consumer located beside a power station development (cogeneration). The greenfield development is based on a high temperature field with deep wells (1750m deep) of average production. The price set for the geothermal cogeneration option is based on achieving the same revenue per tonne of steam for steam which is directed either to a turbine for generating electricity at the wholesale price, or supplied to a heat user located beside the steam mains.

Analysis for the Targets Report (EECA 2007) was done for a carbon cost of NZ\$15/t CO<sub>2</sub> though a higher cost would be assumed now. The higher cost will lift the gas and coal curves and will also have a minor pass-through effect of lifting the geothermal cogeneration cost because of raised wholesale electricity prices<sup>23</sup>. However, this does not change the conclusions.

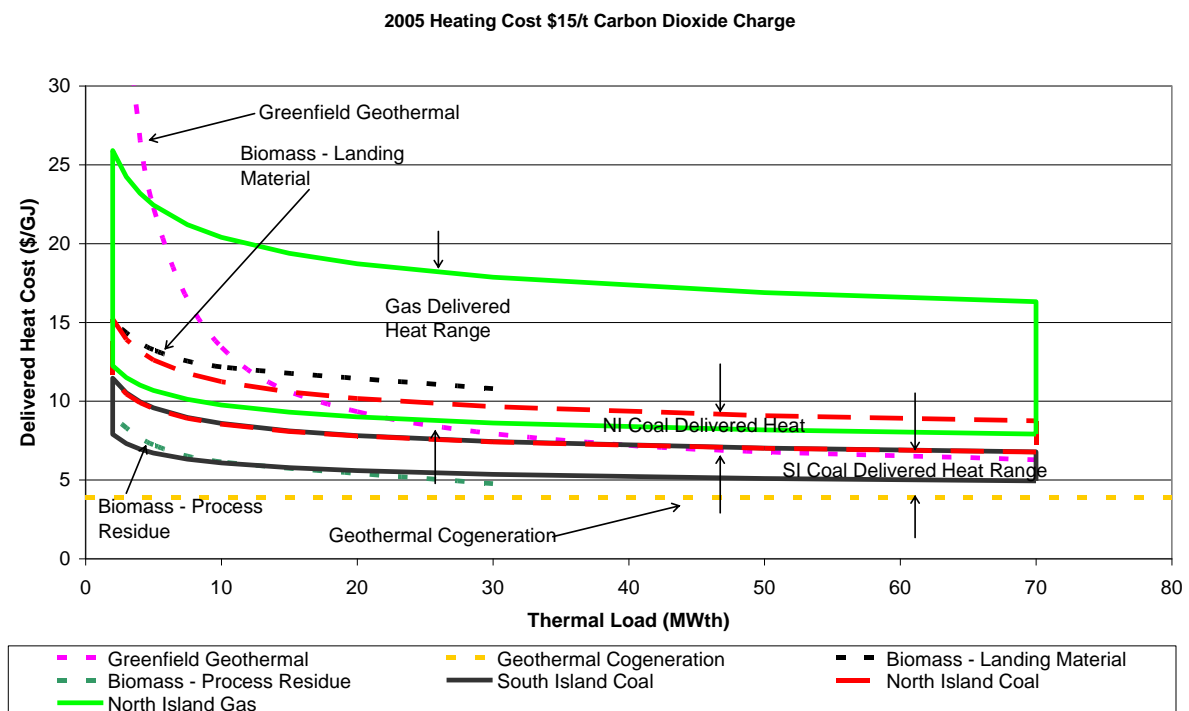

**Figure 4.2** Comparisons of costs of various forms of industrial-scale heating

A developer located beside any geothermal power station requiring steam should be able to negotiate attractive commercial rates, in comparison with the cost of alternatives, for heat supply at almost any scale.

For a greenfield development a heat load of the order of 10 to 20 MWth or greater is required to be clearly competitive with other heat forms. This sort of load could be associated with large timber kiln operations or large glasshouses as examples.

<sup>23</sup> Electricity prices are increased because thermal stations will have to raise their offer prices to cover the increased cost faced by the cost of carbon. In turn, all hydro stations should lift their offer prices or risk dispatch ahead of all thermal generation, which would drain hydro lakes. Almost all other generation is bid in at a zero or near zero price but receives the price of the marginal generator. Thus the whole electricity market will respond according to the response of the thermal generators. Depending on the cost of carbon on international markets, this could increase wholesale electricity price by 1 to 2 c/kWh.

If there are existing wells or a shallow steam zone then these factors can significantly reduce the cost of a direct supply of heat, improving the economics.

#### 4.5 Small-sized Electricity Generation (2 to 30 MW)

Unless there are less tangible benefits such as security of supply, geothermal electricity generation projects must compete with the wholesale price of electricity. Currently this is around 8c/kWh for fixed price contracts, excluding lines costs. A cost applied to carbon of NZ\$25/tonne (it may be higher) of CO<sub>2</sub> is expected to add over 1c/kWh to the wholesale electricity price.

Specific sites may have potential benefits associated with avoidance of transmission costs or distribution reinforcement, or if the generation is embedded in an industrial or large commercial site then it may allow reduced transformer costs on the incoming feed as an example of a benefit to the host. The combination of wholesale price and benefits leads to a hurdle price for investment in electricity generation.

The cost of generation from geothermal energy will primarily be a function of the costs and productivity of the wells and of the resource temperature, excluding any specific site/customer related costs or benefits. The following graph shows expected costs based on typical high temperature geothermal fields. Clearly, where the field has good productivity and high temperatures, then commercial investment in geothermal electricity generation could be considered.

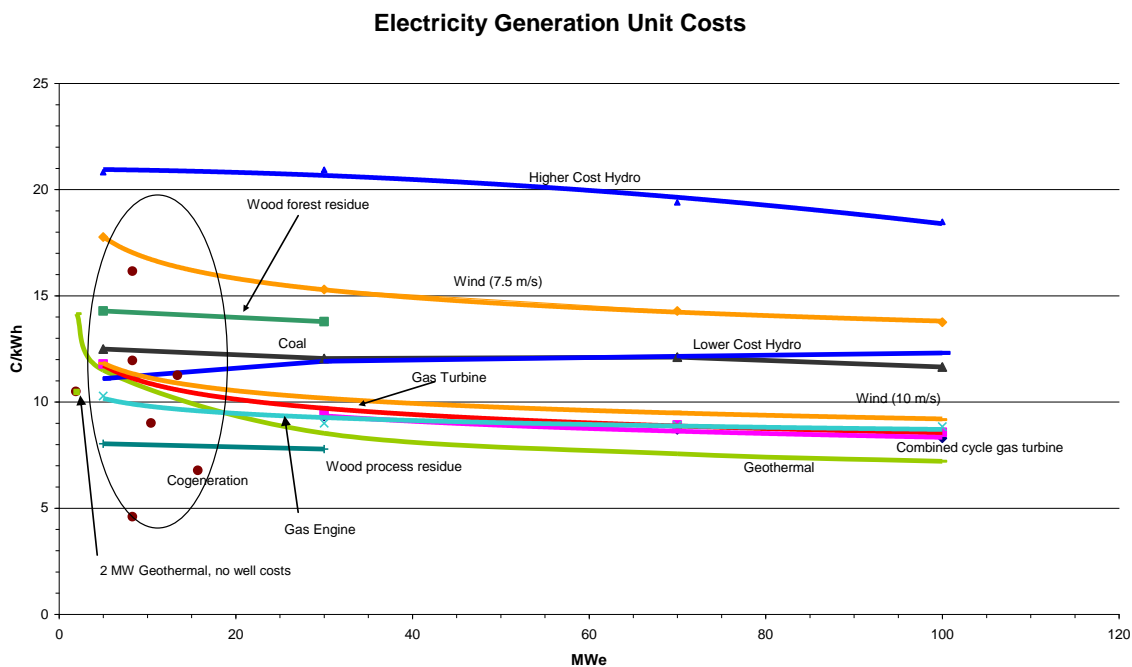

**Figure 4.3** Approximate costs for small-scale electricity generation compared with a range of other generation types.

Figure 4.3 has been adapted from “Lifecycle Costs for Small to Medium Generation Plants” (EECA June 2006) including adjustments for recent price movements. The analysis does not include a cost of carbon which will apply, subject to legislation, from 2009 on thermally generated electricity and is expected to lift prices in the overall market. For other input assumptions to Figure 4.3, refer to the report.

This indicates that geothermal generation operating as baseload is competitive with other generation forms at larger scale, and with a carbon charge the cost relativity will improve. The price remains competitive down to below 10MW. At smaller scale some edge is needed to justify investment, such as locally high electricity prices or availability of historic wells (or steam wells), or a high degree of embedment within a site such that transformer capacity can be reduced at the site boundary, as an example of the effect.

#### **4.6 Mini-sized Electricity Generation (200 kW to 2 MW)**

Mini-sized generation is likely to be more closely embedded within a site or network than the larger developments. Such generation may be matched to underutilised wells or to boiling springs and so effectively shed much of the capital cost (and risk) associated with drilling and well development.

Several examples of 250kW-sized developments have been given in this report, though some of these could be considered of a pilot nature. UTC Power is a new arrival in the market place and have one operating facility at Chena, Alaska. UTC claim to have been able to achieve radical cost reduction through taking advantage of the mass manufacturing of Carrier chiller units while modifying only a small number of components. Consequently, UTC have indicated that they can offer plant at a price they believe will be sustainable in the market: around US\$1,350/kW installed for the power plant only (excluding any fluid collection and disposal costs, costs associated with a cooling system, transformers and distribution line costs, but including system control and instrumentation).

Plant operation and maintenance costs for 250kW stations are expected to be higher per kWh than larger plant as manpower requirement will be similar, but the end result may be a unit cost around the hurdle price discussed in section 4.5.

Clearly, specifics of each case must be assessed.



## 5 Potential For, and Methods To, Increase Uptake of Distributed Energy Opportunities

There is an expectation, both by industry and the Government, that geothermal investment will accelerate given its potential to relieve our dependence on fossil fuels. The following table looks at some investor considerations and suggests how these may be made easier.

	Situation	Response
General concern over rising fuel prices	<p>Rising fuel and electricity prices are causing reconsideration of energy options for all user types. Geothermal energy is seen as a means, in part at least, of isolating the user from future fuel price movement. Clearly the costs associated with the geothermal option must be seen as attractive for this option to be taken up.</p> <p>Equally, if the perception is that energy price is unstable then this may have the effect of delaying a decision on new heat plant until trends have settled.</p>	<p>Any decision to invest in any technology should be strongly economically-based, and there are sensible geothermal options that can minimise fuel costs.</p> <p>Uptake of these options can be accelerated by:</p> <ul style="list-style-type: none"> <li>• Demonstration projects and case studies</li> <li>• Reports highlighting the costs and benefits</li> </ul>
A requirement for reliable and high quality heat supply	<p>In most cases, heating is a means to an end and a necessity, rather than “core business” for the user. Thus heating options should be reliable, trouble-free and should rarely be a cause for concern after installation.</p>	<p>Commercial suppliers must satisfy the need for a quality supply of heat. Geothermal energy can often be supplied reliably at competitive prices compared with alternatives.</p> <p>Careful specification, design and training is required to ensure quality of supply and installation, especially for relatively new products on the New Zealand market such as heat pumps.</p> <p>If designed properly modern geothermal applications, including heat pumps offer fully engineered solutions with automatic control of heat to different locations within a property.</p>
Concern over CO <sub>2</sub> and other air emissions	<p>There is growing concern over the impacts of ongoing CO<sub>2</sub> emissions, particularly with respect to possible impacts on climate change.</p> <p>In a number of locations there is also growing concern over particulate and other emissions from fossil fuel sources. Regional and local councils are imposing restrictions on heating options in places like Rotorua and Christchurch. These restrictions can be accompanied by programmes to replace smoky fires, whether they are wood- or coal-fired, with some form of low emission technology.</p> <p>In both of the cases cited there could be geothermal solutions. In Rotorua, this could include use of shallow wells (possibly with downhole heat exchangers), while in Christchurch geothermal heat pumps could play a part.</p>	<p>Climate change concerns have been given high priority in the broad measures announced by Government in 2007 with respect to the NZES, NZEECS and emissions trading regime.</p> <p>While there is recognition that there is some CO<sub>2</sub> emissions from conventional geothermal resources, the emissions levels are low, especially so for direct heat use, where the efficiency of the application is very high.</p> <p>Investment in geothermal energy options is an appropriate response to emissions concerns.</p>

	<b>Situation</b>	<b>Response</b>
Current knowledge of geothermal resources	<p>Lack of awareness of geothermal opportunities has been a major factor behind the lack of forward momentum. In particular this applies to geothermal heat pumps, and suitable locations for these. Some research has been sponsored by the Foundation for Research Science and Technology, but in general this has not been extensive.</p> <p>Research on low temperature fields is required to define characteristics including their area and vertical extent to help manage risk.</p> <p>High temperature fields are researched by the major developers, but the details of their commercial research is generally confidential, with limited releases through public notices and conference papers.</p>	<p>General mapping of soil conductivities is required to enable a basis for more confident assessment of the potential for ground-coupled geothermal heat pumps.</p> <p>Government is redirecting some R&amp;D funding specifically towards researching low temperature geothermal resources through FRST. Disseminated resource knowledge will enable both developers and local/regional councils to make decisions and manage risk.</p>
Lack of a licensing regime	<p>The lack of a licensing regime as operated for oil and gas exploration means that resource information can be held tightly by current developers thus placing barriers for new entrants to enter the geothermal market. New entrants are deterred by an inability to secure the resource. If they undertake exploration they are not able to follow through with rights to development.</p> <p>In comparison, the oil and gas exploration licensing regime allows exploration companies exclusive access provided they proceed to development within a specified time period. There are also requirements that some geotechnical information is lodged with the Crown Minerals Division of the Ministry of Economic Development. If development does not proceed then the information becomes available to other potential developers. This ensures that a national database of geotechnical data is established.</p>	<p>The introduction of an exploration and development licensing regime similar to that applying to the oil and gas industry may facilitate the entry of new parties into the sector.</p> <p>Note that the New Zealand industry is strongly divided on this issue. While major developers are actively progressing projects, the value of potential benefits through new entrants seem to be outweighed by the need for a stable regulatory environment.</p>
Current knowledge of technology and cost	<p>Conventional fluid extraction technology for exploiting geothermal energy has not changed much in recent years. However, some technologies such as for extraction of heat from enhanced deep geothermal systems and geothermal heat pumps are new to New Zealand, and people are generally not aware of these as options.</p> <p>Heat pumps have been studied in the past, but analysis was based on more expensive options than the new generation of imported units. People are not aware of active installers of heat pump systems. Reduced costs are now starting to make this a viable option, especially for large domestic or commercial developments.</p> <p>Improvements in the design of downhole heat exchangers has opened this technology for wider use. It also has the advantage of extracting heat rather than geothermal fluid which results in significantly fewer geothermal field management issues.</p> <p>Engineered geothermal system technology could be used to access heat, but this has not been applied to direct heat use applications to date (or to electricity generation in New Zealand), because of uncertainties, technical issues and economics.</p> <p>There have been some transforming changes in geothermal costs in recent years. In the last two or three years, rising commodity prices and shipping costs coupled with increased competition for drilling rigs has lifted the price of conventional geothermal generation and heat supply. However, new cheaper sources of heat pumps and small scale binary cycle plants have developed, and design improvements of downhole heat exchangers have improved the economics.</p>	<p>For all applications (heat and electricity generation), case studies and demonstration projects (e.g. of improved Downhole Heat Exchangers) may accelerate uptake, especially if project costs are provided.</p> <p>Specific cost studies need to be undertaken to open up markets e.g. applications of Engineered Geothermal Systems or deep drilling for heating as well as generation applications, or applications of limited district heating.</p> <p>Note that there are markets that just have not opened up because entrepreneurs are not aware of the opportunity.</p>

	<b>Situation</b>	<b>Response</b>
Concern over current levels of domestic heating	It is now recognised that many New Zealand homes are too cold, and that this is impacting on health and therefore income. Consequently, where they can afford to, users may choose to raise home temperatures, either by increasing a building's insulation levels, or simply by increasing heating use.	Geothermal energy can in certain circumstances be a more cost-effective solution for home heating.
Co-location of resource and user	As a rule, geothermal energy applications will be most economic close to the field. There are exceptional cases, such as found in Iceland, where geothermal energy can be piped for 70 km from distant fields before being distributed for heating use.  Energy cost in the past has often not been a major factor in the choice of location for production facilities. With increased energy costs industry may start to consider locating facilities adjacent to energy sources. This sort of decision can take several years to research and commit to.	A conceptual study of long-distance steam transmission could be undertaken.  Field developers could develop an integrated long term utilisation plan for their extended site to attract direct users to relocate to the site. Relationships need to be developed in the long term.  Policies related to the investment environment could be used to ensure that New Zealand remains an attractive market for investment (to avoid a decision to relocate offshore rather than to a lower energy site within New Zealand).
Aversion to high capital expenditure on energy	People are still averse to high capital expenditure on heating options. In the New Zealand domestic market, homes are kept for around 7 years before owners sell and move to another property leaving many consumers concerned that they will not recover their investment over that period.  At the commercial level, whenever plant improvements are being considered, investment criteria are usually based around short payback periods, favouring low capital cost/high fuel cost options.  Whenever a new development is being considered, appropriate energy options will be reviewed by the user. This will also apply to replacement of aging heat plant. These are the few times when the majority of developers will consider full lifecycle costs and may put aside their usual aversion to high capital investment.  Renewable energy options will generally have high capital cost but low fuel cost.	The Home Energy Rating Schemes (HERS) currently being set up by EECA, may allow homeowners to point to benefits that can lead to long term cost reductions for the potential buyer, particularly if potential house purchasers are able to relate energy rating to a dollar value per year or to a sense of comfort level.  Real estate agents (and the public) should be educated on the benefits of energy efficient homes and include information on potential dollar value in their information sheets in the same way they include rates as a consideration.  Government may wish to consider loans or grants as a means of assisting investors make a decision with relatively high capital costs, but low operating costs.  EECA could extend its heat plant database to include a geothermal direct use database
Constraining resource consenting policies	In the past some regional and district councils have taken a cautious approach to consenting. The exception is domestic-level development which has often been possible with just a general authorisation rather than full resource consent application and process.	Environment Waikato has recently revised its Geothermal Plan and its Geothermal Policy Statement, allowing greater clarity in planning.  The Ministry for the Environment is considering the form of a National Policy Statement on Renewable Energy, which is intended to clarify resource consenting issues for renewable energy developments.
Concern over past bore closures	It appears that domestic and commercial development of geothermal direct heat use was progressing well in the central North Island until the forced bore closures in Rotorua in the late 1980s. People had moved to Rotorua to take advantage of the geothermal resource, and there were active drilling programmes and companies designing and installing surface plant including heat exchangers. Significant private capital investment was involved, but then had to be written off.	This decision was clearly linked to one field and use that had clearly proceeded beyond acceptable levels. Regional and District Councils now have an active focus on management of their resources under mandates through the Resource Management Act .

	<b>Situation</b>	<b>Response</b>
Risks and uncertainty associated with development	<p>Any development carries with it significant risk elements, from concept stage through to operations. Where drilling is involved there are some relatively high cost and high risk elements to a development, requiring a 'mining' mentality on the developer's part.</p> <p>Once the field is proven the development of the surface facilities, with their high capital cost but potentially base load operation requires a 'utility' mentality to development.</p>	<p>Risks are commonly managed by existing developers of geothermal resources through a staged approach, where decisions can be made to cut losses when the project is not proceeding as hoped.</p> <p>There is opportunity for Government and industry associations to disseminate general information so that developers understand the risks and potential rewards.</p>

## 6 References

- Alaska Energy Authority (January 2007) "Geothermal Power Plant at Chena Hot Springs, Alaska" report by Chena Power LLC for Alaska Energy Authority
- EECA (June 2006) "Lifecycle Costs for Small to Medium Generation Plants" report by East Harbour Management Services Ltd prepared for Energy Efficiency and Conservation Authority
- EECA (June 2007) "Assessment of Possible Renewable Energy Targets – Direct Use: Geothermal" report by East Harbour Management Services Ltd and GNS Science prepared for Energy Efficiency and Conservation Authority
- Goldbrunner, J (June 2005) "Bad Blumau (Styria, Austria) The Success Story of Combined Use of Geothermal Energy" *Geo-Heat Center Bulletin, June 2005*
- Legmann, H (2003) "The Bad-Blumau Geothermal Project – A Low Temperature, Sustainable and Environmentally Benign Power Plant" *Geothermics, Vol 31, No 4/6, Aug/Dec 2003, Pergamon.*
- Lund, J. W., D.H. Freeston, and T.L. Boyd (2005) "World-Wide Direct Uses of Geothermal Energy 2005". *Proceedings World Geothermal Congress 2005 Antalya, Turkey*
- Mongillo, M and L. Clelland (October 1984) "Concise Listing of Information on the Thermal Areas and Thermal Springs of New Zealand" DSIR Geothermal Report No 9
- NZGA (14 July 2006) "An Assessment of Geothermal Direct Heat Use in New Zealand" New Zealand Geothermal Association Report funded by EECA
- Reyes, A.G. (April 2007) "Sources of Energy for Geothermal Direct Heat Use" GNS Science Report 2007/54
- Thain, I., A.G. Reyes, T. Hunt (June 2006) "A Practical Guide to Exploiting Low Temperature Geothermal Resources" GNS Science Report 2006/09
- Wang, Z and Wang, H (July 2006) "Economic Analysis of Water Source Heat Pump System" *Proceedings of the 7<sup>th</sup> Asian Geothermal Symposium*
- White, B. (November 2007) "Growth in the New Zealand Geothermal Industry" *Paper presented at the 2007 New Zealand Geothermal Association Seminar*
- Yamada, S. and H. Oyama (March 2005) "Small Capacity Geothermal Binary Power Generation System" *Fuji Electric Journal March 2005 (Vol 78 – No. 2)*

## Appendix 1: Description of a Lithium Bromide Absorption Cycle

The following description is taken from "Perry's Chemical Engineers' Handbook"

The absorption cycle is a two-pressure cycle, normally maintaining, with 7 to 8°C outlet chilled water, 0.91 kPa absolute pressure in the evaporator-generator section and 10 kPa absolute pressure in the generator-condenser section. Three circuits are involved:

1. water as a refrigerant is pumped to the evaporator,
2. lithium bromide as the absorbent is circulated over the absorber tubes, through the heat exchanger, and to the generator,
3. cooling water flows in series initially through the absorber tubes and partially through the condenser tubes at about two-thirds of design flow rate.

Water to be cooled enters the evaporator (cooler) tube bundle, where it is cooled indirectly by spray water. The water vapourised is absorbed by a strong solution of lithium bromide at a low pressure. The lithium bromide that has absorbed the water vapour is then pumped through the solution heat exchanger to the generator so as to reconstitute the weak solution. Low-pressure steam (55 to 96 kPa) is used in the generator to boil off the water vapour, thus concentrating the salt solution before re-entering the absorber. The solution flow from the generator to the absorber is the result of gravity and pressure difference and not of pumping. The water boiled off in the generator then is condensed to a liquid in the condenser section, and the condensate is returned to the evaporator.

The heat dissipated in the absorber and condenser is removed by the cooling water. It is necessary for the inlet cooling-water temperatures to be controlled so that the proper cycle concentration will result.